

T B 1 2 4 5 N

VIDEO, CHROMA AND SYNCHRONIZING SIGNALS PROCESSING IC FOR PAL / NTSC / SECAM SYSTEM COLOR TV

TB1245N that is a signal processing IC for the PAL/NTSC/SECAM color TV system integrates video, chroma and synchronizing signal processing circuits together in a 56pin shrink DIP plastic package.

TB1245N incorporates a high performance picture quality compensation circuit in the video section, an automatic PAL/NTSC/SECAM discrimination circuit in the chroma section, and an automatic 50/60 Hz discrimination circuit in the synchronizing section. Besides a crystal oscillator that internally generates 4.43 MHz, 3.58 MHz and M/N-PAL clock signals for color demodulation, there is a horizontal PLL circuit built in the IC.

The PAL/SECAM demodulation circuit which is an adjustment-free circuit incorporates a 1H DL circuit inside for operating the base band signal processing system.

Also, TB1245N makes it possible to set or control various functions through the built-in I²C bus line.

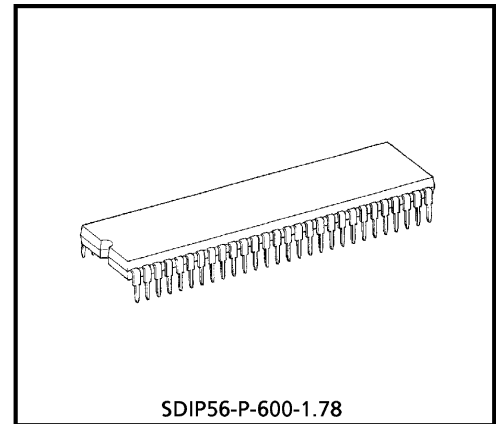

Weight : 5.55 g (Typ.)

980910EBA1

- TOSHIBA is continually working to improve the quality and the reliability of its products. Nevertheless, semiconductor devices in general can malfunction or fail due to their inherent electrical sensitivity and vulnerability to physical stress. It is the responsibility of the buyer, when utilizing TOSHIBA products, to observe standards of safety, and to avoid situations in which a malfunction or failure of a TOSHIBA product could cause loss of human life, bodily injury or damage to property. In developing your designs, please ensure that TOSHIBA products are used within specified operating ranges as set forth in the most recent products specifications. Also, please keep in mind the precautions and conditions set forth in the TOSHIBA Semiconductor Reliability Handbook.
- The products described in this document are subject to the foreign exchange and foreign trade laws.
- The information contained herein is presented only as a guide for the applications of our products. No responsibility is assumed by TOSHIBA CORPORATION for any infringements of intellectual property or other rights of the third parties which may result from its use. No license is granted by implication or otherwise under any intellectual property or other rights of TOSHIBA CORPORATION or others.
- The information contained herein is subject to change without notice.

FEATURES

Video section

- Built-in trap filter
- Black expansion circuit
- Variable DC regeneration rate
- Y delay line
- Sharpness control by aperture control
- γ correction

Chroma section

- Built-in 1 H Delay circuit
- PAL base band demodulation
- One crystal color demodulation circuit
- Automatic system discrimination
- Built-in band-pass filter
- Color limiter circuit

Synchronizing deflecting section

- Built-in horizontal VCO resonator
- Adjustment-free horizontal/vertical oscillation By count-down circuit
- Double AFC circuit
- Vertical frequency automatic discrimination circuit
- Horizontal/vertical holding adjustment
- Vertical ramp output
- Vertical amplitude adjustment
- Vertical linearity/S-shaped curve adjustment
- E/W output



Text section

- Linear RGB input
- OSD RGB input
- Cut/off-drive adjustment
- RGB primary signal output

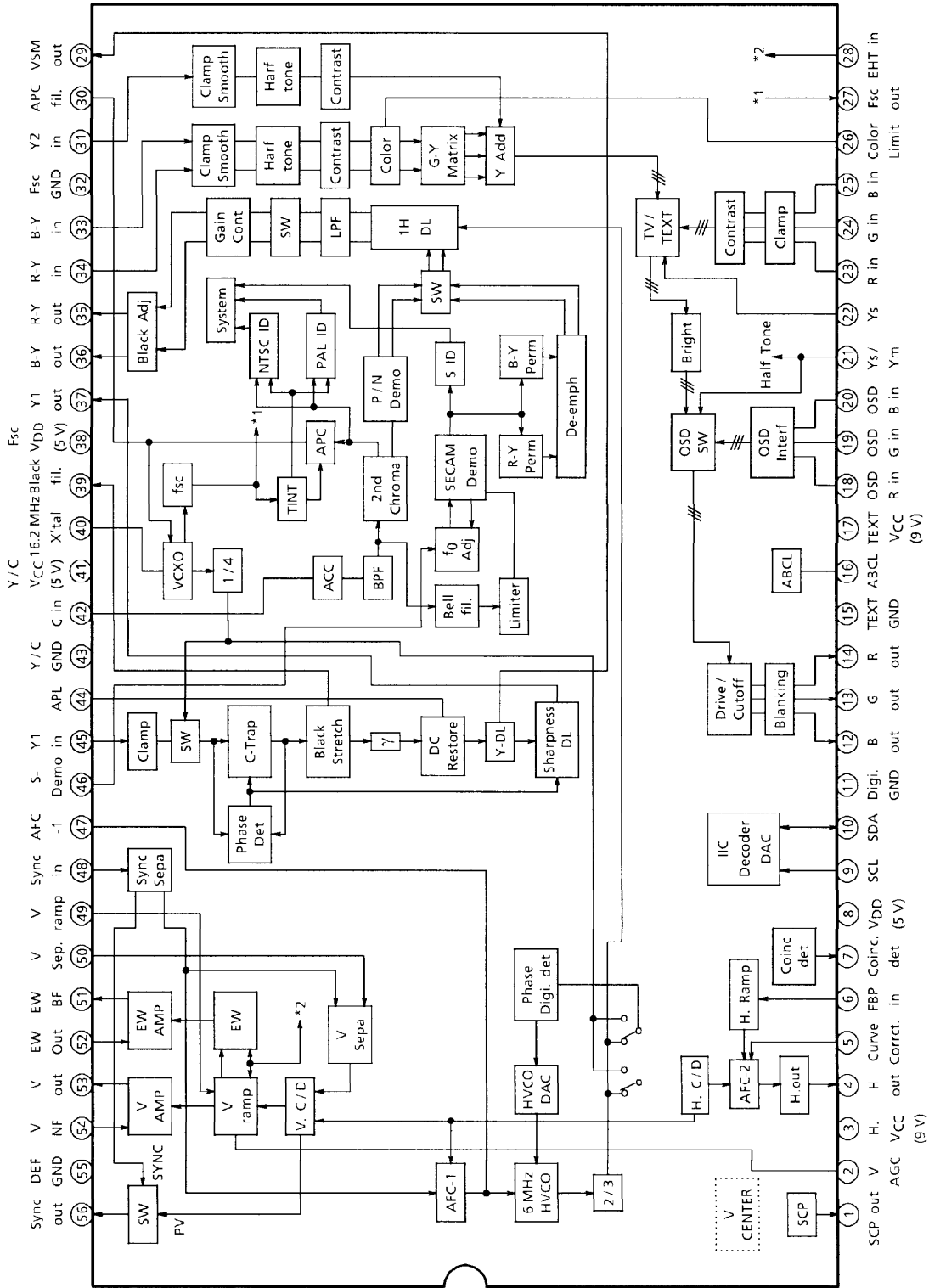
BLOCK DIAGRAM

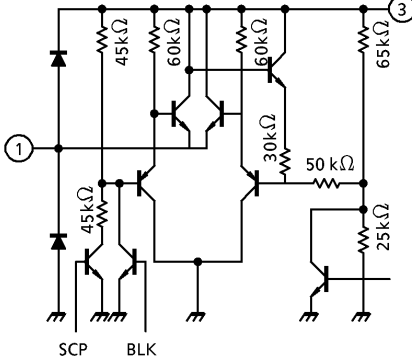
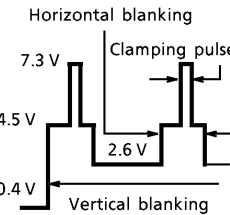
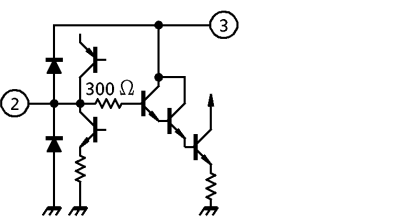
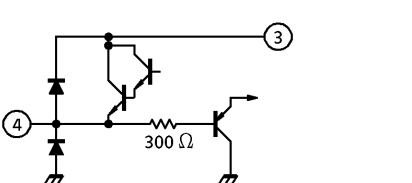

TERMINAL FUNCTIONS

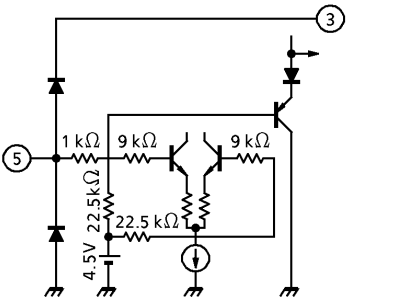
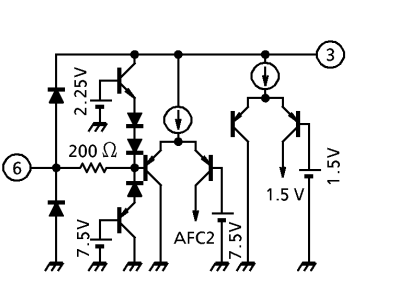
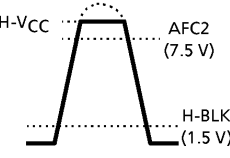
PIN No.	PIN NAME	FUNCTION	INTERFACE CIRCUIT	INPUT / OUTPUT SIGNAL
1	SCP OUTPUT	Output terminal of Sand Castle Pulse. (SCP) To connect drive resistor for SCP.		
2	V-AGC	Controls pin 52 to maintain a uniform V-ramp output. Connect a current smoothing capacitor to this pin.		—
3	H-V _{CC} (9 V)	V _{CC} for the DEF block (deflecting system). Connect 9 V (Typ.) to this pin.	—	—
4	Horizontal Output	Horizontal output terminal.		
5	Picture Distortion Correction	Corrects picture distortion in high voltage variation. Input AC component of high voltage variation. For inactivating the picture distortion correction function, connect 0.01 μF capacitor between this pin and GND.		4.5 V at Open
6	FBP Input	FBP input for generating horizontal AFC2 detection pulse and horizontal blanking pulse. The threshold of horizontal AFC2 detection is set $H.V_{CC} - 2V_f$ ($V_f \approx 0.75 V$). Confirming the power supply voltage, determine the high level of FBP.		

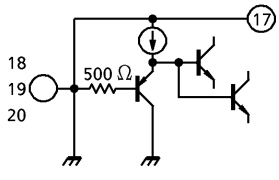
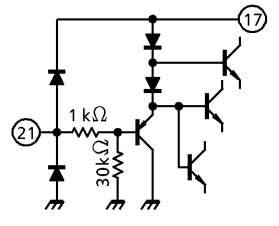
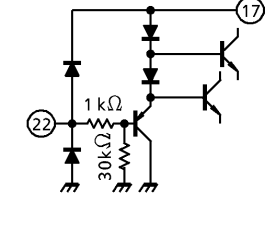
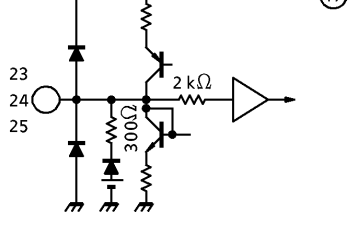
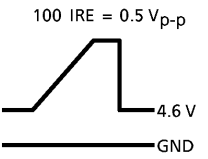
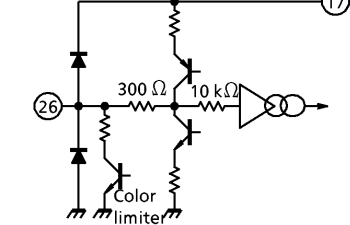
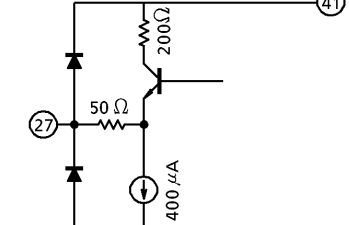
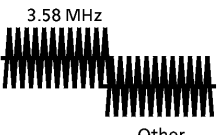

PIN No.	PIN NAME	FUNCTION	INTERFACE CIRCUIT	INPUT / OUTPUT SIGNAL
7	Coincident Det.	To connect filter for detecting presence of H. synchronizing signal or V. synchronizing signal.		—
8	V _{DD} (5 V)	V _{DD} terminal of the LOGIC block. Connect 5 V (Typ.) to this pin.	—	—
9	SCL	SCL terminal of I ² C bus.		—
10	SDA	SDA terminal of I ² C bus.		—
11	Digital GND	Grounding terminal of LOGIC block.	—	—
12 13 14	B Output G Output R Output	R, G, B output terminals.		
15	TEXT GND	Grounding terminal of TEXT block.	—	—
16	ABCL	External unicolor brightness control terminal. Sensitivity and start point of ABL can be set through the bus.		6.4 V at Open
17	RGB-V _{CC} (9 V)	V _{CC} terminal of TEXT block. Connect 9 V (Typ.) to this pin.	—	—



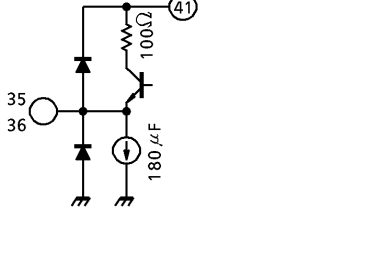
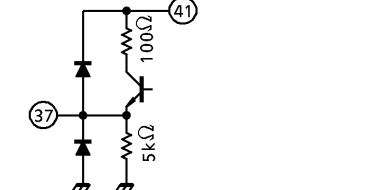
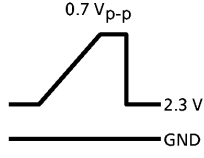
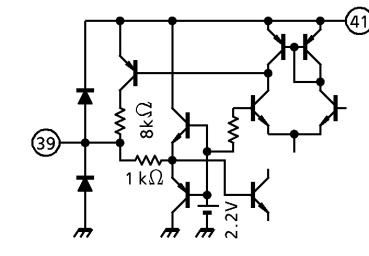
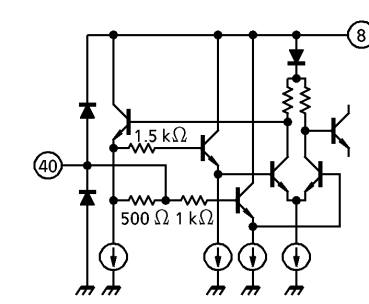

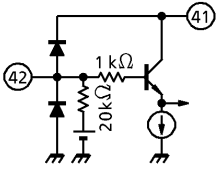
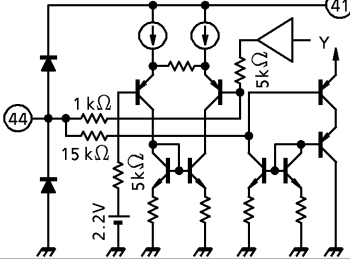
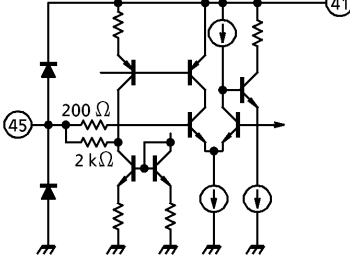
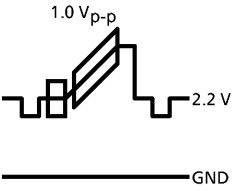
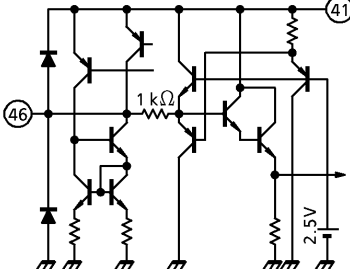
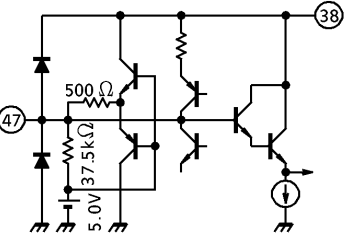
PIN No.	PIN NAME	FUNCTION	INTERFACE CIRCUIT	INPUT / OUTPUT SIGNAL
18 19 20	Digital R Input Digital G Input Digital B Input	Input terminals of digital R, G, B signals. Input DC directly to these pins. OSD or TEXT signal can be input to these pins.		OSD — 3.0 V TEXT — 2.0 V — GND
21	Digital YS / YM	Selector switch of halftone / internal RGB signal / digital RGB (pins 18, 19, 20).		OSD — 3.2 V TEXT — 2.1 V H.T. — 0.7 V TV — GND
22	Analog YS	Selector switch of internal RGB signal or analog RGB (pins 23, 24, 25).		Analog RGB — 0.5 V TV — GND
23 24 25	Analog R Input Analog G Input Analog B Input	Analog R, G, B input terminals. Input signal through the clamping capacitor. Standard input level : 0.5 V _{p-p} (100 IRE).		100 IRE = 0.5 V _{p-p}  — GND
26	Color Limiter	To connect filter for detecting color limit.		—
27	FSC Output	Output terminal of FSC.		3.58 MHz  Other 500 mVp-p

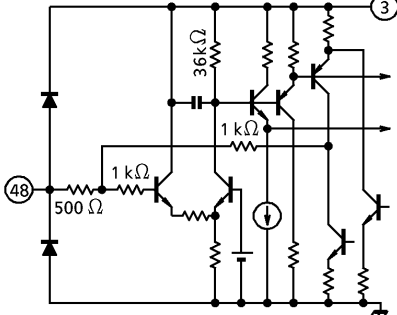
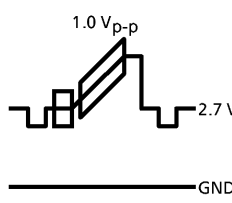
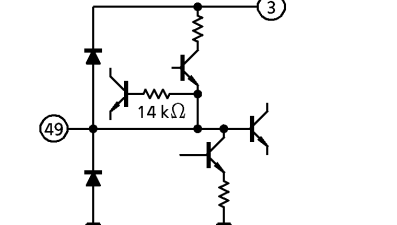
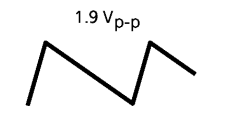
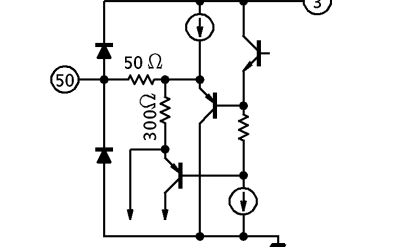
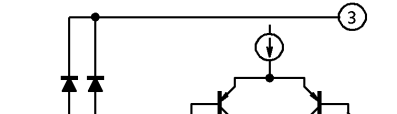
PIN No.	PIN NAME	FUNCTION	INTERFACE CIRCUIT	INPUT / OUTPUT SIGNAL
28	EHT Input	Input terminal of EHT.		—
29	VSM Output Terminal	Power output the signal that is primary differentiated Y signal. Enable to change output amplifier and phase by the Bus.		—
30	APC Filter	To connect APC filter for chroma demodulation.		DC 3.2 V
31	Y ₂ Input	Input terminal of processed Y signal. Input Y signal through clamping capacitor. Standard input level : 0.7 V _{p-p}		
32	Fsc GND	Grounding terminal of VCXO block. Insert a decoupling capacitor between this pin and pin 38 (Fsc V _{DD}) at the shortest distance from both.	—	—
33 34	B-Y Input R-Y Input	Input terminal of B-Y or R-Y signal. Input signal through a clamping capacitor.		DC 2.5 V AC B-Y : 650 mV _{p-p} R-Y : 510 mV _{p-p} (with input of PAL-75% color bar signal)

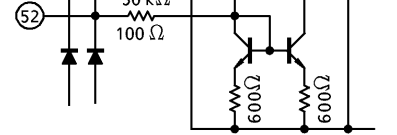
PIN No.	PIN NAME	FUNCTION	INTERFACE CIRCUIT	INPUT / OUTPUT SIGNAL
35 36	R-Y Output B-Y Output	Output terminal of demodulated R-Y or B-Y signal. There is an LPF for removing carrier built in this pin.		DC 1.9 V AC B-Y : 650 mV _{p-p} R-Y : 510 mV _{p-p} (with input of PAL-75% color bar signal)
37	Y ₁ Output	Output terminal of processed Y signal. Standard output level : 0.7 V _{p-p}		
38	Fsc V _{DD}	V _{DD} terminal of DDS block. Insert a decoupling capacitor between this pin and pin 32 (Fsc GND) at the shortest distance from both. If decoupling capacitor is inserted at a distance from the pins, it may cause spurious deterioration.	—	—
39	Black Stretch	To connect filter for controlling black expansion gain of the black expansion circuit. Black expansion gain is determined by voltage of this pin.		DC 1.6 V
40	16.2 MHz X'tal	To connect 16.2 MHz crystal clock for generating sub-carrier. Lowest resonance frequency (f ₀) of the crystal oscillation can be varied by changing DC capacity. Adjust f ₀ of the oscillation frequency with the board pattern.		DC 4.1 V

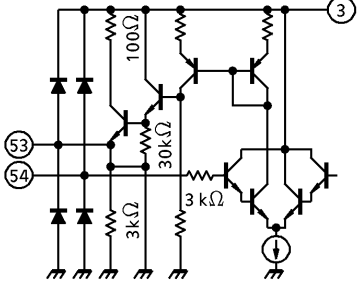
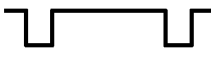
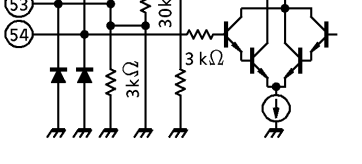
PIN No.	PIN NAME	FUNCTION	INTERFACE CIRCUIT	INPUT / OUTPUT SIGNAL
41	Y/C V _{CC} (5 V)	V _{CC} terminal of Y/C signal processing block.	—	—
42	Chroma Input	Chroma signal input terminal. Input negative 1.0 V _{p-p} sync composite video signal to this pin through a coupling capacitor.		DC 2.4 V AC : 300 mV _{p-p} burst
43	Y/C GND	Grounding terminal of Y/C signal processing block.	—	—
44	APL	To connect filter for DC regeneration compensation. Y signal after black expansion can be monitored by opening this pin.		DC 2.2 V
45	Y ₁ Input	Input terminal of Y signal. Input negative 1.0 V _{p-p} sync composite video signal to this pin through a clamping capacitor.		
46	S-Demo-Adj.	To connect f ₀ adjustment filter for SECAM demodulation.		DC 3.2 V
48	AFC1 Filter	To connect filter for horizontal AFC1 detection. Horizontal frequency is determined by voltage of this pin.		DC 5.0 V

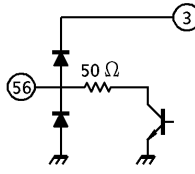
PIN No.	PIN NAME	FUNCTION	INTERFACE CIRCUIT	INPUT / OUTPUT SIGNAL
48	Sync Input	Input terminal of synchronizing separator circuit. Input signal through a clamping capacitor to this pin. Negative 1.0 V _{p-p} sync.		
49	V-Ramp	To connect filter for generating V-ramp waveform.		
50	V-Sepa.	To connect filter for vertical synchronizing separation.		DC 5.9 V
51	EW FB	E/W feedback terminal		
52	EW OUT	Output terminal for driving E/W		

PIN No.	PIN NAME	FUNCTION	INTERFACE CIRCUIT	INPUT / OUTPUT SIGNAL
53	Vertical Output	Output terminal of vertical ramp signal.		
54	V-NF	Input terminal of vertical NF signal.		
55	DEF GND	Grounding terminal of DEF (deflection) block.	—	—
56	Sync Output	Output terminal of synchronizing signal separated by sync separator circuit. Connect a pull-up resistor to this pin because it is an open-collector output type.		

BUS CONTROL MAP

WRITE DATA

Slave address : 88 Hex (10001000)

SUB AD-DRESS	D ₇ MSB	D ₆	D ₅	D ₄	D ₃	D ₂	D ₁	D ₀ LSB	PRESET					
									MSB	LSB				
00	UNI-COLOR									1000	0000			
01	BRIGHT									1000	0000			
02	COLOR									1000	0000			
03	N-COMB	TINT									0100	0000		
04	PN-ID	BLK SW	SHARPNESS									0010	0000	
05	S-D-Trap	R-Moni	B-Moni	Y SUB CONTRAST									1001	0000
06	RGB-CONTRAST									1000	0000			
07	OSD LEVEL		0	0	0	0	0	0	0000	0000				
08	Y _γ	WPL	DRG SW	BLUE BACK			Y-DL			0000	0010			
09	G DRIVE									1000	0000			
0A	B DRIVE									1000	0000			
0B	HORIZONTAL POSITION					AFC MODE		H-CK SW		1000	0001			
0C	R CUTOFF									0000	0000			
0D	G CUTOFF									0000	0000			
0E	B CUTOFF									0000	0000			
0F	BS SW	C-TRAP	OFST SW	C-BPF	P/N GP	CLL SW	WBLK SW	V-AGC	0000	0000				
10	S-INHBIT	0	F-BW	X'tal MODE			COLOR SYSTEM			0000	0000			
11	R-Y BLACK OFFSET				B-Y BLACK OFFSET						1000	1000		
12	CLL LEVEL		PN CD ATT		BPF Q		BPF f ₀			1001	1010			
13	H-STOP1	VSM PH	VSM GAIN		C-TRAP Q		C-TRAP f ₀			1011	1010			
14	BLACK STRACK POINT			DC TRAN RATE			APA-CON f ₀			1000	0010			
15	ABL POINT			ABL GAIN			HALF TONE SW			0000	0000			
16	H BLANKING PHASE			V-CD		V OUT PHASE					0000	0000		
17	VERTICAL SIZE						SYNC/VP	ZOOM SW		1000	0000			
18	HORIZONTAL SIZE						COINCIDENT DET			1000	0010			
19	E/W PARABOLA					V-FREQ					1000	0000		
1A	V-LIN CORRECTION				V-S CORRECTION						1000	1000		
1B	E/W TRAPEZIUM				E/W CORNER						1000	1000		
1C	MUTE MODE		H COMPENSATION			V COMPENSATION					0100	0000		
1D	NOISE DET		V-BLK START PHASE								1011	1111		
1E	H-STOP2	V-BLK STOP PHASE									0000	0000		
1F	S-FIELD	S-CD ATT	DEMP f ₀	S GP	V-ID SW	S KIL	BELL f ₀			0000	0001			

READ-IN DATA

Slave address : 89 Hex (10001001)

SUB AD-DRESS	D ₇ MSB	D ₆	D ₅	D ₄	D ₃	D ₂	D ₁	D ₀ LSB
1	PORES	COLOR SYSTEM		X'tal		V-FREQ	V-STD	N-DET
2	LOCK	RGB OUT	Y1-IN	UV-IN	Y2-IN	H	V	V-GUARD

BUS CONTROL FUNCTION

WRITE FUNCTION

ITEM	DESCRIPTION	NUMBER OF BITS	VARIABLE RANGE	PRESET VALUE
UNI-COLOR	—	8 bit	- 18 dB~0 dB	80h CENTER VALUE
BRIGHT	—	8 bit	- 40 IRE ~ 40 IRE	80h CENTER VALUE
COLOR	—	8 bit	~4 dB	80h 0 dB
N COMB	1H addition selection	1 bit	OFF / ADD	00h OFF
TINT	—	7 bit	- 32°~32°	40h 0°
P / N ID	P / N IDENT sensitivity control	1 bit	Normal / Low (DIGITAL Comb FILTER use : - 3 dB)	00h NORMAL
BLK SW	Blanking ON / OFF	1 bit	ON / OFF	00h ON
SHARPNESS	—	6 bit	~14 dB	20h + 3 dB
S-D-Trap	SECAM double trap ON / OFF	1 bit	ON / OFF	01h OFF
R-Mon	TEXT-11 dB pre-amplification UV output	1 bit	Normal / Monitor (Pin 36)	00h Normal
B-Mon	TEXT-11 dB pre-amplification UV output	1 bit	Normal / Monitor (Pin 35)	00h Normal
Y SUB CONTRAST	—	5 bit	- 3 dB~ + 3 dB	10h 0 dB
RGB-CONTRAST	EXT RGB UNI-COLOR control	8 bit	- 18 dB~0 dB	80h CENTER VALUE
OSD LEVEL		2 bit	2.15, 2.27, 2.38, 2.50 V _{p-p}	00h 2.15 V _{p-p}
Y γ	γ ON / OFF	1 bit	OFF / ON (95 IRE)	00h ON
WPL	White peak limit level	1 bit	ON (130 IRE) / OFF	00h 130 IRE
DRG SW	Drive reference axis selection	1 bit	R / G	00h R
BLUE BACK	Luminance selector switch	2 bit	IRE ; OFF, 40, 50, 60	00h OFF
Y-DL	Y-DL TIME (280, 330, 380, 430, 480)	3 bit	280~480 ns after Y IN (101H~111H : Not used)	02h 380 ns
G DRIVE GAIN	—	8 bit	- 5 dB~3 dB	80h CENTER VALUE
B DRIVE GAIN	—	8 bit	- 5 dB~3 dB	80h CENTER VALUE
HORIZONTAL POSITION	Horizontal position adjustment	5 bit	- 3 μ s~ + 3 μ s	10h 0 μ s

ITEM	DESCRIPTION	NUMBER OF BITS	VARIABLE RANGE	PRESET VALUE
AFC MODE	AFC1 detection sensitivity selector	2 bit	dB ; AUTO, 0, -10, -10	00h AUTO
H-CK SW	HOUT generation clock selector	1 bit	384 fh-VCO, FSC-VCXO	01h FSC-VCXO
R CUT OFF	—	8 bit	-0.5~0.5 V	00h -0.5 V
G CUT OFF	—	8 bit	-0.5~0.5 V	00h -0.5 V
B CUT OFF	—	8 bit	-0.5~0.5 V	00h -0.5 V
BS OFF	Black stretch ON/OFF	1 bit	ON/OFF	00h ON
C-TRAP	Chroma Trap ON/OFF SW	1 bit	ON/OFF	00h ON
OFST SW	Black offset SECAM discrimination interlocking switch	1 bit	SECAM only / All systems	00h S only
C-BPF	P/N BPF ON/OFF SW	1 bit	ON/OFF	00h ON
P/N GP	PAL GATE position	1 bit	Standard / 0.5 μ s delay	00h Standard
CLL SW	COLOR LIMIT ON/OFF	1 bit	ON/OFF	00h ON
WBLK SW	WIDE V-BLK ON/OFF	1 bit	OFF/ON	00h OFF
V-AGC	V-AGC switch	1 bit	Normal / Fast	00h Normal
S-INHBT	To detect or not to detect SECAM	1 bit	Yes/No	00h Yes
F-BW	Force B/W switch	1 bit	AUTO/Forced B/W	00h AUTO
X'tal MODE	APC oscillation frequency selector switch	3 bit	000 ; European system AUTO, 001 ; 3N 010 ; 4P, 011 ; 4P (N inhibited) 100 ; S.American system AUTO, 101 ; 3N, 110 ; MP, 111 ; NP	00h European system AUTO
COLOR SYSTEM	Chroma system selection	2 bit	AUTO, PAL, NTSC, SECAM	00h AUTO
R-Y BLACK OFFSET	R-Y color difference output black offset adjustment	4 bit	-24~21 mV STEP 3 mV	08h 0 mV
B-Y BLACK OFFSET	B-Y color difference output black offset adjustment	4 bit	-24~21 mV STEP 3 mV	08h 0 mV
CLL LEVEL	Color limit level adjustment	2 bit	91, 100, 108, 116%	02h 108%

(Note) : 3N ; 3.58-NTSC, 4P ; 4.43-PAL, MP ; M-PAL, NP ; N-PAL
European system AUTO ; 4.43-PAL, 4.43-NTSC, 3.58-NTSC, SECAM
S.American system AUTO ; 3.58-NTSC, M-PAL, N-PAL

ITEM	DESCRIPTION	NUMBER OF BITS	VARIABLE RANGE	PRESET VALUE
PN CD ATT	P/N color difference amplitude adjustment	2 bit	-2~ +1 dB STEP 1 dB	01h 0 dB
BPF Q	TOF Q adjustment	2 bit	1.0, 1.5, 2.0, 2.5	02h 2.0
BPF f ₀	TOF f ₀ adjustment	2 bit	kHz ; 0, 500, 600, 700	02h 600 kHz
H-STOP1	H-OUT ON/OFF SW1	1 bit	H-STOP2 = 1 and H-STOP1 = 1 → STOP	00h OUTPUT
VSM PHASE	VSM output phase	1 bit	0 ns, +20 ns	00h 0 ns
VSM GAIN	VSM output gain	2 bit	0 dB, 0 dB, -6 dB, OFF	03h OFF
C-TRAP Q	Chroma trap Q control	2 bit	1.0, 1.5, 2.0, 2.5	02h 2.0
C-TRAP F ₀	Chroma trap f ₀ control	2 bit	kHz ; -100, -50, 0, +50	02h 0 kHz
BLACK STRETCH POINT	Black expansion start point setting	3 bit	27~70% IRE × 0.4	05h 51.6% IRE
DC TRAN RATE	Direct transmission compensation degree selection	3 bit	100~130% APL	00h 100% APL
APA-CON PEAK f ₀	Sharpness peak frequency selection	2 bit	MHz ; 2.5, 3.1, 4.2, OFF	02h 4.2 MHz
ABL POINT	ABL detection voltage	3 bit	ABL point ; 5.9 V~6.5 V	00h 5.9 V
ABL GAIN	ABL sensitivity	3 bit	Brightness ; 0~ -2 V	00h 0 V
HALF TONE SW	Halftone gain selection	2 bit	Normal + Pin control, Forced -6 dB Normal (not pin control)	00h Normal
H BLK PHASE	Horizontal blanking end position	3 bit	0~3.5 μs step 0.5 μs	00h 0 μs
V-CD	Vertical count-down mode selection	2 bit	Normal / Normal / Teletext / Fast	00h Normal
V OUTPUT PHASE	Vertical position adjustment	3 bit	0~7H STEP 1H	00h 0H
VERTICAL SIZE	Vertical amplitude adjustment	6 bit	-45~ +45%	20h CENTER VALUE
SYNC/VP	SYNC OUT/VP OUT OUTPUT Select, PIN 56	1 bit	SYNC OUT / VP OUT	00h SYNC OUT
ZOOM SW	Vertical ZOOM	1 bit	Normal / ZOOM	00h Normal
HORIZONTAL SIZE	Horizontal amplitude adjustment	6 bit	1.5~6.5 V	20h CENTER VALUE
COINCIDENT MODE	Discriminator output signal selection	2 bit	00 ; DSYNC 01 ; DSYNC × AFC 10 ; Field counting 11 ; VP is present.	02h Field counting
E/W PARABOLA	Parabola amplitude adjustment	5 bit	0~2.7 V	10h CENTER VALUE
V FREQ	Vertical frequency	3 bit	AUTO, 50 Hz, 60 Hz, No Use, Forced 312.5H, Forced 313H, Forced 262.5H, Forced 263H	00h AUTO

ITEM	DESCRIPTION	NUMBER OF BITS	VARIABLE RANGE	PRESET VALUE
V-LINE CORRECTION	Vertical linearity correction	4 bit	- 13~ + 13%	08h CENTER VALUE
V S-CORRECTION	Vertical S-curve correction	4 bit	- 16~ + 13%	08h CENTER VALUE
E / W TRAPEZIUM	Parabola symmetry correction	4 bit	- 10~ + 10%	10h CENTER VALUE
E / W CORNER	Corner correction	4 bit	- 1.5~ + 1.5 V	10h CENTER VALUE
MUTE MODE	OFF, RGB mute, Y mute, transverse	2 bit	OFF, RGB, Y, Transverse	01h RGB
H-COMPENSATION	Horizontal EHT correction	3 bit	0~1.0 V	00h 0 V
V-COMPENSATION	Vertical EHT correction	3 bit	0~9%	00h 0%
NOISE DET	Noise detection level selection	2 bit	0.12, 0.25, 0.39, 0.55	02h 0.39
V-BLK START PHASE	Vertical pre-position selection	6 bit	- 64~ - 1H STEP 1H	3Fh - 1H
H-STOP2	H-OUT ON / OFF SW2	1 bit	H-STOP2 = 1 and H-STOP1 = 1 → OUTPUT	00h OUTPUT
V-BLK STOP PHASE	Vertical post-position selection	7 bit	0~128H STEP 1H	00h 0H
S-FIELD	SECAM color and Q selection in weak electric field	1 bit	Weak electric field control ON / OFF	00h ON
S-CD ATT	SECAM color difference amplitude adjustment	1 bit	0 / - 1 dB	00h 0 dB
DEMO F ₀	SECAM deemphasis time constant selection	1 bit	85 kHz / 100 kHz	00h 85 kHz
S GP	SECAM gate position selection	1 bit	Standard / 0.5 μs delay	00h Standard
V-ID SW	SECAM V-ID ON / OFF switch	1 bit	OFF / ON	00h OFF
S KIL	SECAM KILLER sensitivity selection	1 bit	NORMAL / LOW (- 3 dB)	00h NORMAL
BELL F ₀	Bell f ₀ adjustment	2 bit	- 46~92 kHz STEP 46 kHz	01h 0 kHz

READ-IN FUNCTION

ITEM	DESCRIPTION	NUMBER OF BITS
PONRES	0 : POR cancel, 1 : POR ON	1 bit
COLOR SYSTEM	00 : B/W, 01 : PAL 10 : NTSC, 11 : SECAM	2 bit
X'tal	00 : 4.433619 MHz 01 : 3.579545 MHz 10 : 3.575611 MHz (M-PAL) 11 : 3.582056 MHz (N-PAL)	2 bit
V-FREQ	0 : 50 Hz, 1 : 60 Hz	1 bit
V-STD	0 : NON-STD, 1 : STD	1 bit
N-DET	0 : Low, 1 : High	1 bit
LOCK	0 : UN-LOCK, 1 : LOCK	1 bit
RGBOUT, Y ₁ -IN UV-IN, Y ₂ -IN, H, V	Self-diagnosis 0 : NG, 1 : OK	1 bit each
V-GUARD	Detection of breaking neck 0 : Abnormal, 1 : Normal	1 bit

DATA TRANSFER FORMAT VIA I²C BUS

Start and stop condition

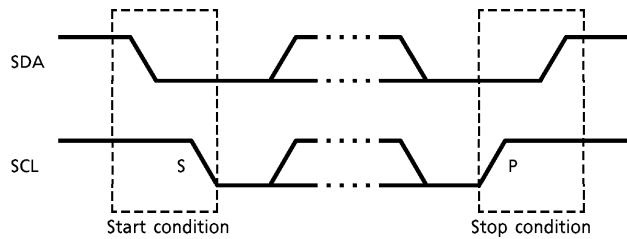

Bit transfer

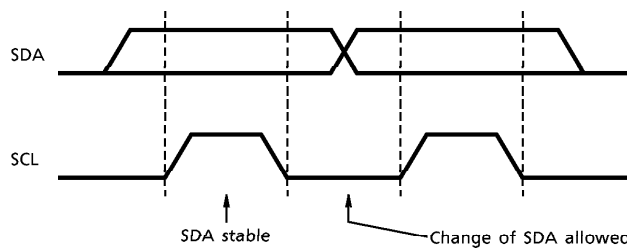

Acknowledge

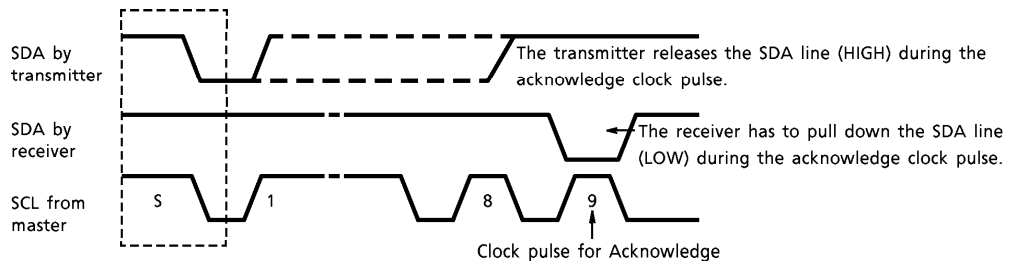

Data transmit format 1

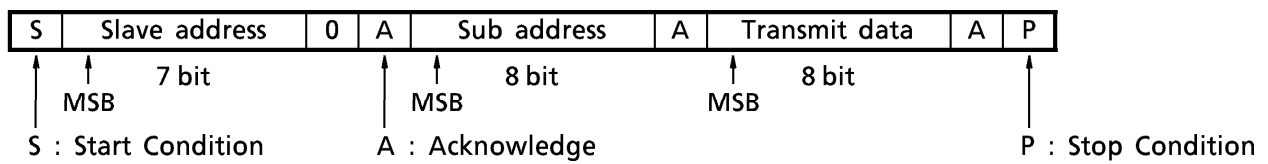

Data transmit format 2

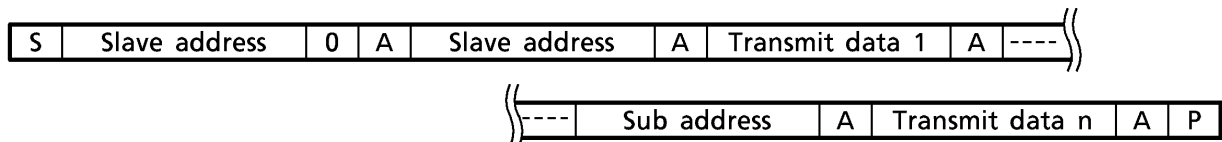

Data receive format

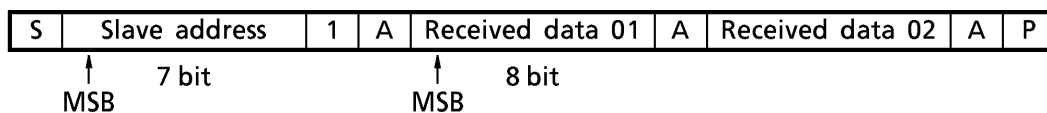

At the moment of the first acknowledge, the master transmitter becomes a master receiver and the slave receiver becomes a slave transmitter. This acknowledge is still generated by the slave.

The STOP condition is generated by the master.



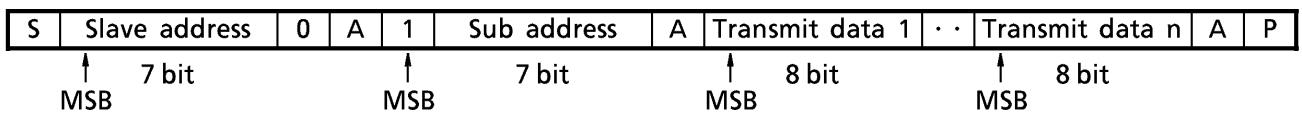





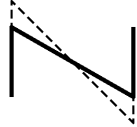
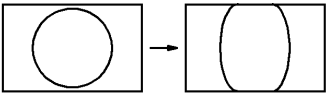

Optional data transmit format : Automatic increment mode

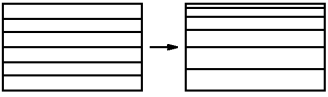

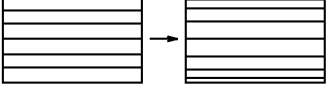

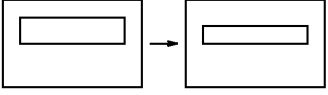
In this transmission method, data is set on automatically incremented sub-address from the specified sub-address.

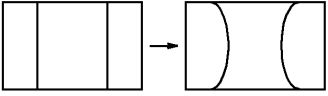
Purchase of TOSHIBA I²C components conveys a license under the Philips I²C Patent Rights to use these components in an I²C system, provided that the system conforms to the I²C Standard Specification as defined by Philips.

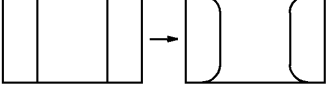
DEFLECTION CORRECTION TABLE

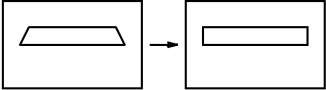
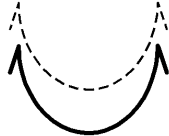
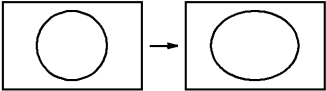
FUNCTION	OUTPUT WAVEFORM	PICTURE CHANGE	VARIABLE RANGE
Vertical Amplitude Adjustment [VERTICAL SIZE]		<p>Typ. Large value</p>  <p>(Solid line at left) (Dotted line at left)</p>	- 45~ + 45%
Vertical Linearity Correction [V-LINEARITY]		<p>Typ. Large value</p>  <p>(Solid line at left) Lower stretching, upper compression</p>	- 13~ + 13%
Vertical S Correction [V-S CORRECTION]		<p>Typ. Large value</p>  <p>(Solid line at left) Upper and lower compression</p>	- 16~ + 16%
Vertical EHT Correction [V-COMPENSATION]		<p>Typ. Large value</p>  <p>(Solid line at left) (Dotted line at left)</p>	0~9%
Parabola Amplitude Adjustment [EW PARABOLA]		<p>Typ. Small value</p>  <p>(Solid line at left) (Dotted line at left)</p>	0~2.7 V
Corner Correction [EW CORNER]		<p>Typ. Large value</p>  <p>(Solid line at left) (Dotted line at left)</p>	- 1.5~ + 1.5 V

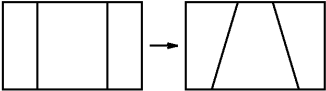
FUNCTION	OUTPUT WAVEFORM	PICTURE CHANGE	VARIABLE RANGE
Horizontal EHT Correction [H-COMPENSATION]		Typ. Large value  (Solid line at left) (Dotted line at left)	0~ + 1.0 V%
Horizontal Amplitude Adjustment [HORIZONTAL SIZE]		Typ. Large value  (Solid line at left) (Dotted line at left)	1.5~6.5 V
Parabola Symmetry Correction [EW TRAPEZIUM]		Typ. Small value  (Solid line at left) (Dotted line at left)	- 10~ + 10%

MAXIMUM RATINGS (Ta = 25°C)

CHARACTERISTIC	SYMBOL	RATING	UNIT
Supply Voltage	V _{CCMAX}	12	V
Permissible Loss	P _{DMAX}	2190 (Note 1)	mW
Power Consumption Declining Degree	1/Q _{ja}	17.52	mW/°C
Input Terminal Voltage	V _{in}	GND - 0.3~V _{CC} + 0.3	V
Input Signal Voltage	e _{in}	7	V _{p-p}
Operating Temperature	T _{opr}	- 20~65	°C
Conserving Temperature	T _{stg}	- 55~150	°C

(Note 1) : In the condition that IC is actually mounted. See the diagram below.

(Note 2) : This IC is not proof enough against a strong E-M field by CRT which may cause function errors and /or poor characteristics.

Keeping the distance from CRT to the IC longer than 20 cm, or if cannot, placing shield metal over the IC, is recommended in an application.

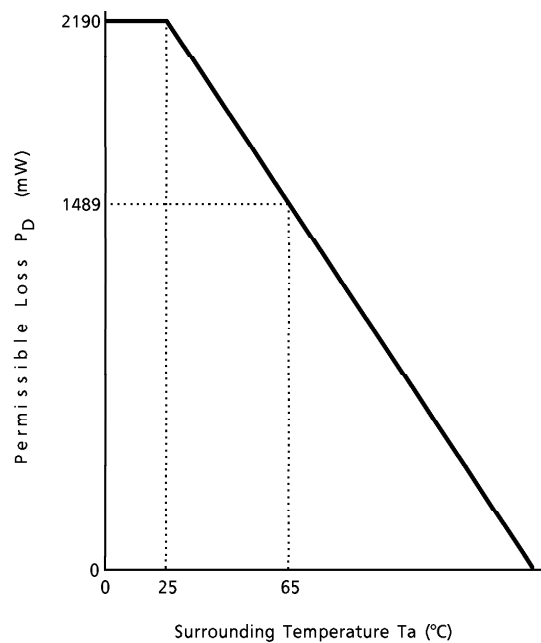

Fig. Power consumption declining curve relative to temperature change

RECOMMENDED OPERATING CONDITION

CHARACTERISTIC	DESCRIPTION	MIN.	TYP.	MAX.	UNIT
Supply Voltage	Pin 3, pin 17	8.50	9.0	9.50	V
	Pin 8, pin 38, pin 41	4.75	5.0	5.25	
Video Input Level	100% white, negative sync	0.9	1.0	1.1	V_{p-p}
Chroma Input Level		0.9	1.0	1.1	
Sync Input Level		0.9	1.0	2.2	
FBP Width	—	11	12	13	μs
Incoming FBP Current (Note)	—	—	—	1.5	mA
H. Output Current	—	—	1.0	2.0	
RGB Output Current	—	—	1.0	2.0	V
Analog RGB Input Level	—	—	0.7	0.8	
OSD RGB Input Level	In TEXT input	0.7	1.0	1.3	
	In OSD input	—	4.2	5.0	
Incoming Current to Pin 56	Sync-out	—	0.5	1.0	mA

(Note) : The threshold of horizontal AFC2 detection is set $H.V_{CC} - 2V_f$ ($V_f \approx 0.75V$).
Confirming the power supply voltage, determine the high level of FBP.

ELECTRICAL CHARACTERISTIC

(Unless otherwise specified, H, RGB $V_{CC} = 0V$, V_{DD} , Fsc V_{DD} ,
Y/C $V_{CC} = 5V$, $T_a = 25 \pm 3^\circ C$)

CURRENT CONSUMPTION

PIN No.	CHARACTERISTIC	SYMBOL	TEST CIRCUIT	MIN.	TYP.	MAX.	UNIT
3	H.V _{CC} (9V)	I _{CC1}	—	16.0	19.0	23.5	mA
8	V _{DD} (5V)	I _{CC2}	—	8.8	11.0	14.0	
17	RGB V _{CC} (9V)	I _{CC3}	—	25.0	31.5	39.0	
38	Fsc V _{CC} (5V)	I _{CC4}	—	1.0	1.5	2.0	
41	Y/C V _{CC} (9V)	I _{CC5}	—	70	90	120	

TERMINAL VOLTAGE

PIN No.	PIN NAME	SYMBOL	TEST CIRCUIT	MIN.	TYP.	MAX.	UNIT
16	ABCL	V ₁₆	—	5.9	6.4	6.9	V
18	OSD R Input	V ₁₈	—	—	0	0.3	V
19	OSD G Input	V ₁₉	—	—	0	0.3	V
20	OSD B Input	V ₂₀	—	—	0	0.3	V
21	Digital Ys	V ₂₁	—	—	0	0.3	V
22	Analog Ys	V ₂₂	—	—	0	0.3	V
23	Analog R Input	V ₂₃	—	4.2	4.6	5.0	V
24	Analog G Input	V ₂₄	—	4.2	4.6	5.0	V
25	Analog B Input	V ₂₅	—	4.2	4.6	5.0	V
28	ETH Input	V ₂₈	—	—	—	—	V
31	Y ₂ Input	V ₃₁	—	1.7	2.0	2.3	V
33	B-Y Input	V ₃₃	—	2.2	2.5	2.8	V
34	R-Y Input	V ₃₄	—	2.2	2.5	2.8	V
35	R-Y Output	V ₃₅	—	1.5	1.9	2.3	V
36	B-Y Output	V ₃₆	—	1.5	1.9	2.3	V
37	Y ₁ Output	V ₃₇	—	1.9	2.3	2.7	V
40	16.2 MHz X'tal Oscillation	V ₄₀	—	3.6	4.1	4.6	V
42	Chroma Input	V ₄₂	—	2.0	2.4	2.8	V
50	V-Sepa.	V ₅₀	—	5.4	5.9	6.4	V

AC CHARACTERISTIC
Video section

CHARACTERISTIC	SYMBOL	TEST CIRCUIT	TEST CONDITION	MIN.	TYP.	MAX.	UNIT
Y Input Pedestal Clamping Voltage	VYclp	—	(Note) Y ₁	2.0	2.2	2.4	V
Chroma Trap Frequency	ftr3	—	(Note) Y ₂	3.429	3.58	3.679	MHz
	ftr4	—		4.203	4.43	4.633	
Chroma Trap Attenuation (3.58 MHz) (4.43 MHz) (SECAM)	Gtr3a	—	(Note) Y ₃	20	26	52	dB
	Gtr3f	—	(Note) Y ₄	20	26	52	
	Gtr4	—	(Note) Y ₅	18	26	52	
	Gtrs	—	(Note) Y ₆	90	95	99	
Y γ Correction Point	γ p	—	(Note) Y ₇	-2.6	-2.0	-1.3	dB
Y γ Correction Curve	γ c	—	(Note) Y ₈	15	20	25	k Ω
APL Terminal Output Impedance	Zo44	—	(Note) Y ₉	0.11	0.13	0.15	times
	Adrmax	—		0.44	0.06	0.08	
DC Transmission Compensation Amplifier Gain	Adrcnt	—	(Note) Y ₁₀	1.20	1.5	1.65	
Maximum Gain of Black Expansion Amplifier	Ake	—	(Note) Y ₁₁	65	77.5	80	IRE
	VBS9MX	—		55	62.5	70	
	VBS9CT	—		48	55.5	63	
	VBS9MN	—		35	42.5	50	
	VBS2MX	—		25	31.5	38	
	VBS2CT	—		19	25.5	32	
Black Expansion Start Point	TbpH	—	(Note) Y ₁₂	15	16	17	μ s
	TbpV	—		33	34	35	H
Black Peak Detection Period (Horizontal) (Vertical)	fp25	—	(Note) Y ₁₃	1.5	2.5	3.4	MHz
	fp31	—		1.9	3.1	4.3	
	fp42	—		3.0	4.2	5.4	
Picture Quality Control Peaking Frequency	GS25MX	—	(Note) Y ₁₄	12.0	14.5	17.0	dB
	GS31MX	—		12.0	14.5	17.0	
	GS42MX	—		10.6	13.5	16.4	
Picture Quality Control Maximum Characteristic	GS25MN	—	(Note) Y ₁₅	-22.0	-19.5	-17.0	dB
	GS31MN	—		-22.0	-19.5	-17.0	
	GS42MN	—		-19.5	-16.5	-13.5	
Picture Quality Control Minimum Characteristic	GS25CT	—	(Note) Y ₁₆	6.0	8.5	11.0	dB
	GS31CT	—		6.0	8.5	11.0	
	GS42CT	—		4.6	7.5	10.4	
Picture Quality Control Center Characteristic	Gy	—	(Note) Y ₁₇	-1.0	0	1.6	
Y Signal Gain	Gfy	—	(Note) Y ₁₈	-6.5	0	1.0	
Y Signal Frequency Characteristic	Vyd	—	(Note) Y ₁₉	0.9	1.2	1.5	V
Y Signal Maximum Input Range							

Chroma section

CHARACTERISTIC	SYMBOL	TEST CIRCUIT	TEST CONDITION	MIN.	TYP.	MIN.	UNIT	
ACC Characteristic $f_o = 3.58$	3N _e AT	—	(Note) C ₁	30	35	90	mV _{p-p}	
	3N _F 1T	—		68	85	105		
	3N _A T	—		0.9	1.0	1.1	times	
	3N _e AE	—		18	35	—		
	3N _F 1E	—		71	85	102		
	3N _A E	—		0.9	1.0	1.1		
$f_o = 4.43$	4N _e AT	—		18	35	—	mV _{p-p}	
	4N _F 1T	—		71	85	102		
	4N _A T	—		0.9	1.0	1.1	times	
	4N _e AE	—		18	35	—		
	4N _F 1E	—		71	85	102		
	4N _A E	—		0.9	1.0	1.1		
Band Pass Filter Characteristic $f_o = 3.58$	3Nf _o 0	—	(Note) C ₂	3.43	3.579	3.73	MHz	
	3Nf _o 500	—		3.93	4.079	4.23		
	3Nf _o 600	—		4.03	4.179	4.33		
	3Nf _o 700	—		4.13	4.279	4.43		
	$f_o = 4.43$	4Nf _o 0		—	4.28	4.433		4.58
		4Nf _o 500		—	4.78	4.933		4.58
		4Nf _o 600		—	4.88	5.033		5.18
		4Nf _o 700		—	4.98	5.133		5.28
Band Pass Filter, -3 dB Band Characteristic $f_o = 3.58$	f _o 0	—	(Note) C ₃	1.64	1.79	1.94		
	f _o 500	—						
	f _o 600	—						
	f _o 700	—						
	$f_o = 4.43$	f _o 0		—	2.07	2.22		2.37
		f _o 500		—				
		f _o 600		—				
		f _o 700		—				
Band Pass Filter, Q Characteristic Check $f_o = 3.58$	Q ₁	—	(Note) C ₄	—	3.58	—		
	Q _{1.5}	—		—	2.39	—		
	Q _{2.0}	—		1.64	1.79	1.94		
	Q _{2.5}	—		—	1.43	—		
	$f_o = 4.43$	Q ₁		—	—	4.43	—	
		Q _{1.5}		—	—	2.95	—	
		Q _{2.0}		—	2.07	2.22	2.37	
		Q _{2.5}		—	—	1.77	—	

CHARACTERISTIC	SYMBOL	TEST CIRCUIT	TEST CONDITION	MIN.	TYP.	MAX.	UNIT	
1/2 f _c Trap Characteristic f _o = 3.58	f _o	—	(Note) C ₅	1.45	1.60	1.75	MHz	
	f _{o500}	—		1.70	1.85	2.00		
	f _{o600}	—		1.75	1.90	2.06		
	f _{o700}	—		1.80	1.95	2.10		
	f _o = 4.43	f _o		—	1.85	2.00		2.15
		f _{o500}		—	2.00	2.15		2.30
		f _{o600}		—	2.05	2.20		2.35
		f _{o700}		—	2.10	2.25		2.40
Tint Control Range (f _o = 600 kHz)	3NΔθ ₁	—	(Note) C ₆	35.0	45.0	55.0	°	
	3NΔθ ₂	—		- 55.0	- 45.0	- 35.0		
	4NΔθ ₁	—		35.0	45.0	55.0		
	4NΔθ ₂	—						
Tint Control Variable Range (f _o = 600 kHz)	3NΔθ _T	—	(Note) C ₇	70.0	90.0	110.0		
	4NΔθ _T	—						
Tint Control Characteristic	3Tθ _{Tin}	—	(Note) C ₈	39	40	47	bit	
	3Eθ _{Tin}	—						
	3NΔ _{Tin}	—		73	80	87	Step	
	4Tθ _{Tin}	—		39	40	47	bit	
	4Eθ _{Tin}	—						
	4NΔ _{Tin}	—		73	80	87	Step	
APC Lead-In Range (Lead-In Range)	4.433PH	—	(Note) C ₉	350	500	1500	Hz	
	4.433PL	—		- 350	- 500	- 1500		
	3.579PH	—		350	500	1700		
	3.579PL	—		- 350	- 500	- 1700		
	(Variable Range)	4.433HH		—	400	500		1100
		4.433HL		—	- 400	- 500		- 1100
		3.579HH		—	400	500		1100
		3.579HL		—	- 400	- 500		- 1100
APC Control Sensitivity	3.58β ₃	—	(Note) C ₁₀	1.50	2.2	2.90	—	
	4.43β ₃	—		1.70	2.4	3.10		
	M-PALβ _M	—						
	N-PALβ _N	—		1.50	2.2	2.90		

CHARACTERISTIC	SYMBOL	TEST CIRCUIT	TEST CONDITION	MIN.	TYP.	MAX.	UNIT	
Killer Operation Input Level	3N-VTK1	—	(Note) C ₁₁	1.8	2.5	3.2	mV _{p-p}	
	3N-VTC1	—		2.2	3.2	4.0		
	3N-VTK2	—		2.5	3.6	4.5		
	3N-VTC2	—		3.2	4.5	5.6		
	4N-VTK1	—		1.8	2.5	3.2		
	4N-VTC1	—		2.2	3.2	4.0		
	4N-VTK2	—		2.5	3.6	4.5		
	4N-VTC2	—		3.2	4.5	5.6		
	4P-VTK1	—		1.8	2.5	3.2		
	4P-VTC1	—		2.2	3.2	4.0		
	4P-VTK2	—		2.5	3.6	4.5		
	4P-VTC2	—		3.2	4.5	5.6		
	MP-VTK1	—		1.8	2.5	3.2		
	MP-VTC1	—		2.2	3.2	4.0		
	MP-VTK2	—		2.5	3.6	4.5		
	MP-VTC2	—		3.2	4.5	5.6		
	NP-VTK1	—		1.8	2.5	3.2		
	NP-VTC1	—		2.2	3.2	4.0		
NP-VTK2	—	2.5	3.6	4.5				
NP-VTC2	—	3.2	4.5	5.6				
Color Difference Output (Rainbow Color Bar)	3NeB-Y	—	(Note) C ₁₂	320	380	460		
	3NeR-Y	—		240	290	350		
	4NeB-Y	—		320	380	460		
	4NeR-Y	—		240	290	350		
	4PeB-Y	—		360	430	520		
	4PeR-Y	—		200	240	290		
	(75% Color Bar)	4Peb-y		—	540	650		780
		4Per-y		—	430	510		610
Demodulation Relative Amplitude	3NG _R /B	—	(Note) C ₁₃	0.69	0.77	0.86	times	
	4NG _R /B	—		0.70	0.77	0.85		
	4PG _R /B	—		0.49	0.56	0.64		
Demodulation Relative Phase	3Nθ _R -B	—	(Note) C ₁₄	85	93	100	°	
	4Nθ _R -B	—		87	93	99		
	4Pθ _R -B	—		85	90	95		
Demodulation Output Residual Carrier	3N-SCB	—	(Note) C ₁₅	0	5	15	mV _{p-p}	
	3N-SCR	—						
	4N-SCB	—						
	4N-SCR	—						

CHARACTERISTIC	SYMBOL	TEST CIRCUIT	TEST CONDITION	MIN.	TYP.	MAX.	UNIT
Demodulation Output Residual Higher Harmonic	3N-HCB	—	(Note) C16	0	10	30	mV _{p-p}
	3N-HCR	—					
	4N-HCB	—					
	4N-HCR	—					
Color Difference Output ATT Check	B-Y - 1 dB	—	(Note) C17	- 1.20	- 0.9	- 0.60	dB
	B-Y - 2 dB	—		- 2.30	- 1.7	- 1.55	
	B-Y + 1 dB	—		0.60	0.8	1.20	
16.2 MHz Oscillation Frequency	Δ foF	—	(Note) C18	- 2.0	0	2.0	kHz
16.2 MHz Oscillation Start Voltage	V _{Fon1}	—	(Note) C19	3.0	3.2	3.4	V
f _{sc} Free-Run Frequency (3.58 M) (4.43 M) (M-PAL) (N-PAL)	3fr	—	(Note) C20	- 100	50	200	Hz
	4fr	—		- 125	25	175	
	Mfr	—		- 140	10	160	
	Nfr	—					
f _{sc} Output Amplitude	4.43e27	—	(Note) C21	420	500	580	mV _{p-p}
	3.58e27	—					
f _{sc} Output DC Voltage	3.58eV27	—	—	2.6	2.9	3.2	V
	0th V27	—		1.6	1.9	2.2	

DEF section

CHARACTERISTIC	SYMBOL	TEST CIRCUIT	TEST CONDITION	MIN.	TYP.	MAX.	UNIT
H. Reference Frequency	FHVCO	—	(Note) DH1	5.95	6.0	6.10	MHz
H. Reference Oscillation Start Voltage	VSHVCO	—	(Note) DH2	2.3	2.6	2.9	V
H. Output Frequency 1	fH1	—	(Note) DH3	15.5	15.625	15.72	kHz
H. Output Frequency 2	fH2	—	(Note) DH4	15.62	15.734	15.84	
H. Output Duty 1	H ϕ 1	—	(Note) DH5	39	41	43	%
H. Output Duty 2	H ϕ 2	—	(Note) DH6	35	37	39	
H. Output Duty Switching Voltage 1	V ₅₋₁	—	(Note) DH7	1.2	1.5	1.8	V
H. Output Voltage	VHH	—	(Note) DH8	4.5	5.0	5.5	
	VHL	—		—	—	0.5	
H. Output Oscillation Start Voltage	VHS	—	(Note) DH9	—	5.0	—	
H. FBP Phase	ϕ FBP	—	(Note) DH10	6.2	6.9	7.6	μ s
H. Picture Position, Maximum	HSFTmax	—	(Note) DH11	17.7	18.4	19.1	
H. Picture Position, Minimum	HSFTmin	—	(Note) DH12	12.4	13.1	13.8	
H. Picture Position Control Range	Δ HSFT	—	(Note) DH13	4.5	5.3	6.1	μ s/V
H. Distortion Correction Control Range	Δ HCC	—	(Note) DH14	0.5	1.0	1.5	
H. BLK Phase	ϕ BLK	—	(Note) DH15	6.2	6.9	7.6	μ s
H. BLK Width, Minimum	BLKmin	—	(Note) DH16	9.8	10.5	11.3	
H. BLK Width, Maximum	BLKmax	—	(Note) DH17	13.2	14.0	14.7	
P/N-GP Start Phase 1	SPGP1	—	(Note) DH18	3.45	3.68	3.90	
P/N-GP Start Phase 2	SPGP2	—	(Note) DH19	3.95	4.18	4.40	
P/N-GP Gate Width 1	PGPW1	—	(Note) DH20	1.65	1.75	1.85	
P/N-GP Gate Width 2	PGPW2	—	(Note) DH21	1.70	1.75	1.85	
SECAM-GP Start Phase 1	SSGP1	—	(Note) DH22	5.2	5.4	5.6	
SECAM-GP Start Phase 2	SSGP2	—	(Note) DH23	5.7	6.0	6.2	
SECAM-GP Gate Width 1	SGPW1	—	(Note) DH24	1.9	2.0	2.1	
SECAM-GP Gate Width 2	SGPW2	—	(Note) DH25	1.9	2.0	2.1	
Noise Detection Level 1	NL1	—	(Note) DH26	0.09	0.12	0.15	V
Noise Detection Level 2	NL2	—	(Note) DH27	0.20	0.25	0.31	
Noise Detection Level 3	NL3	—	(Note) DH28	0.31	0.39	0.49	
Noise Detection Level 4	NL4	—	(Note) DH29	0.44	0.55	0.68	

CHARACTERISTIC	SYMBOL	TEST CIRCUIT	TEST CONDITION	MIN.	TYP.	MAX.	UNIT
AFC-MASK Start Phase	ϕ AFCf	—	(Note) DV1	2.6	3.2	3.8	H
AFC-MASK Stop Phase	ϕ AFCe	—	(Note) DV2	4.4	5.0	5.6	
VNFB phase	ϕ VNFB	—	(Note) DV3	0.45	0.75	1.05	
V. Output Maximum Phase	$V\phi$ max	—	(Note) DV4	7.3	8.0	8.7	
V. Output Minimum Phase	$V\phi$ min	—	(Note) DV5	0.5	1.0	1.5	
V. Output Phase Variable Range	$\Delta V\phi$	—	(Note) DV6	6.3	7.0	7.7	
50 System VBLK Start Phase	V50BLKf	—	(Note) DV7	0.4	0.55	0.7	
50 System VBLK Stop Phase	V50BLKe	—	(Note) DV8	20	23	26	
60 System VBLK Start Phase	V60BLKf	—	(Note) DV9	0.4	0.55	0.7	
60 System VBLK Stop Phase	V60BLKe	—	(Note) DV10	15	18	21	
Pin 56 VBLK Max Voltage	V56H	—		4.7	5.0	5.3	V
Pin 56 VBLK Min Voltage	V56L	—		0	—	0.3	
V. Lead-In Range 1	VAcaL	—	(Note) DV11	—	224.5	—	Hz
	VAcaH	—		—	344.5	—	
V. Lead-In Range 2	V60caL	—	(Note) DV12	—	224.5	—	
	V60caH	—		—	294.5	—	
VBLK Start Phase	SWVB	—	(Note) DV13	9	—	88	H
VBLK Stop Phase	STWVB	—	(Note) DV14	10	—	120	

Deflection correction stage

CHARACTERISTICS	SYMBOL	TEST CIR-CUIT	TEST CONDITIONS	MIN.	TYP.	MAX.	UNIT
Vertical Ramp Amplitude	V _{P49}	—	(Note G1)	1.76	1.95	2.15	V _{p-p}
Vertical Amplification	G _V	—	(Note G2)	20	26	32	dB
Vertical Amp Maximum Output Voltage	V _{H53}	—	(Note G3)	2.5	3	3.5	V
Vertical Amp Minimum Output Voltage	V _{L53}	—	(Note G4)	—	0	0.3	V
Vertical Amp Maximum Output Current	I _{MAX1}	—	(Note G5)	32	45	58	mA
Vertical NF Sawtooth Wave Amplitude	V _{P54}	—	(Note G6)	1.62	1.8	1.98	V _{p-p}
Vertical Amplitude Range	V _{PH}	—	(Note G7)	±41	±45	±49	%
Vertical Linearity Correction Maximum Value	V _ℓ	—	(Note G8)	±10	±13	±16	%
Vertical S Correction Maximum Value	V _S	—	(Note G9)	±11	±16	±21	%
Vertical NF Center Voltage	V _C	—	(Note G10)	4.3	4.5	4.7	V _{p-p}
Vertical Amplitude EHT Correction	V _{EHT}	—	(Note G11)	8	9	10	%
EHT Dynamic Range	V _L	—	(Note G12)	1.3	1.8	2.3	V
	V _H	—		5.7	6.2	6.7	
E-W NF Maximum DC Value (Picture Width)	V _{H51}	—	(Note G13)	5.5	6.5	7.5	V
E-W NF Minimum DC Value (Picture Width)	V _{L51}	—	(Note G14)	0.55	1.5	2.45	V
E-W NF Parabola Maximum Value (Parabola)	V _{PB}	—	(Note G15)	2.2	2.7	3.2	V _{p-p}
E-W NF Corner Correction (Corner)	V _{CR}	—	(Note G16)	2	3	4	V _{p-p}
Parabola Symmetry Correction	V _{TR}	—	(Note G17)	8	10	12	%
E-W Parabola EHT Value	V _{EH1}	—	(Note G18)	2	3.3	4.5	%
E-W DC EHT Value	V _{EH2}	—	(Note G19)	0.6	1	1.4	V
E-W Amp Maximum Output Current	I _{MAX2}	—	(Note G20)	0.14	0.2	0.28	mA
AGC Operating Current 1	V _{AGC0}	—	(Note G21)	160	200	240	μA
AGC Operating Current 2	V _{AGC1}	—	(Note G22)	480	600	720	μA
Vertical Guard Voltage	V _{VG}	—	(Note G23)	0.8	1	1.2	V
V Centering DAC Output	I ₅₄	—	(Note G24)	—	10	100	nA

1H DL section

CHARACTERISTIC	SYMBOL	TEST CIR-CUIT	TEST CONDITION	MIN.	TYP.	MAX.	UNIT																																																																																																																															
1HDL Dynamic Range, Direct	VNBD	—	(Note) H ₁	0.8	1.2	—	V																																																																																																																															
	VNRD	—						1HDL Dynamic Range, Delay	VPBD	—	(Note) H ₂	0.8	1.2	—	VPRD	—	1HDL Dynamic Range, Direct + Delay	VSBD	—	(Note) H ₃	0.9	1.2	—	VSRD	—	Frequency Characteristic, Direct	GHB1	—	(Note) H ₄	-3.0	-2.0	0.5	dB	GHR1	—	Frequency Characteristic, Delay	GHB2	—	(Note) H ₅	-8.2	-6.5	-4.3	GHR2	—	AC Gain, Direct	GBY1	—	(Note) H ₆	-2.0	-0.5	2.0	GRY1	—	AC Gain, Delay	GBY2	—	(Note) H ₇	-2.4	-0.5	1.1	GRY2	—	Direct-Delay AC Gain Difference	GBYD	—	(Note) H ₈	-1.0	0.0	1.0	GRYD	—	Color Difference Output DC Stepping	VBD	—	(Note) H ₉	-5	0.0	5	mV	VRD	—	1H Delay Quantity	BDt	—	(Note) H ₁₀	63.7	64.0	64.4	μ s	RDt	—	Color Difference Output	Bomin	—	(Note) H ₁₁	22	36	55	mV	DC-Offset Control	Bomax	—	-55	-36	-22	Bus-Min Data	Romin	—	22	36	55	Bus-Max Data	Romax	—	-55	-36	-22	Color Difference Output DC-Offset Control / Min. Control Quantity	Bo1	—	(Note) H ₁₂	1	4	8	Ro1	—	NTSC Mode Gain / NTSC-COM Gain	GNB	—	(Note) H ₁₃	-0.90	0	1.20	dB
1HDL Dynamic Range, Delay	VPBD	—	(Note) H ₂	0.8	1.2	—																																																																																																																																
	VPRD	—						1HDL Dynamic Range, Direct + Delay	VSBD	—	(Note) H ₃	0.9	1.2	—	VSRD	—	Frequency Characteristic, Direct	GHB1	—	(Note) H ₄	-3.0	-2.0	0.5	dB	GHR1	—	Frequency Characteristic, Delay	GHB2	—	(Note) H ₅	-8.2	-6.5		-4.3	GHR2	—	AC Gain, Direct	GBY1	—	(Note) H ₆	-2.0	-0.5	2.0	GRY1	—	AC Gain, Delay	GBY2	—	(Note) H ₇	-2.4	-0.5	1.1	GRY2	—	Direct-Delay AC Gain Difference	GBYD	—	(Note) H ₈	-1.0	0.0	1.0	GRYD	—	Color Difference Output DC Stepping	VBD	—	(Note) H ₉	-5	0.0	5	mV	VRD	—	1H Delay Quantity	BDt	—	(Note) H ₁₀	63.7	64.0	64.4	μ s	RDt	—	Color Difference Output	Bomin	—	(Note) H ₁₁	22	36	55	mV	DC-Offset Control	Bomax	—		-55	-36	-22		Bus-Min Data	Romin	—	22	36	55	Bus-Max Data	Romax	—	-55	-36	-22	Color Difference Output DC-Offset Control / Min. Control Quantity	Bo1	—	(Note) H ₁₂	1	4	8	Ro1	—	NTSC Mode Gain / NTSC-COM Gain	GNB	—	(Note) H ₁₃	-0.90	0	1.20	dB	GNR	—	0.92	0	1.58	
1HDL Dynamic Range, Direct + Delay	VSBD	—	(Note) H ₃	0.9	1.2	—																																																																																																																																
	VSRD	—						Frequency Characteristic, Direct	GHB1	—	(Note) H ₄	-3.0	-2.0	0.5	dB	GHR1	—	Frequency Characteristic, Delay	GHB2	—	(Note) H ₅	-8.2	-6.5		-4.3	GHR2	—	AC Gain, Direct	GBY1	—	(Note) H ₆	-2.0		-0.5	2.0	GRY1	—	AC Gain, Delay	GBY2	—	(Note) H ₇	-2.4	-0.5	1.1	GRY2	—	Direct-Delay AC Gain Difference	GBYD	—	(Note) H ₈	-1.0	0.0	1.0	GRYD	—	Color Difference Output DC Stepping	VBD	—	(Note) H ₉	-5	0.0	5	mV	VRD	—	1H Delay Quantity	BDt	—	(Note) H ₁₀	63.7	64.0	64.4	μ s	RDt	—	Color Difference Output	Bomin	—	(Note) H ₁₁	22	36	55	mV	DC-Offset Control	Bomax	—		-55	-36	-22		Bus-Min Data	Romin	—	22	36	55	Bus-Max Data		Romax	—	-55	-36	-22	Color Difference Output DC-Offset Control / Min. Control Quantity	Bo1	—	(Note) H ₁₂	1	4	8	Ro1	—	NTSC Mode Gain / NTSC-COM Gain	GNB	—	(Note) H ₁₃	-0.90	0	1.20	dB	GNR	—	0.92	0	1.58								
Frequency Characteristic, Direct	GHB1	—	(Note) H ₄	-3.0	-2.0	0.5	dB																																																																																																																															
	GHR1	—						Frequency Characteristic, Delay	GHB2	—	(Note) H ₅	-8.2	-6.5	-4.3		GHR2	—	AC Gain, Direct	GBY1	—	(Note) H ₆	-2.0	-0.5		2.0	GRY1	—	AC Gain, Delay	GBY2	—	(Note) H ₇	-2.4		-0.5	1.1	GRY2	—	Direct-Delay AC Gain Difference	GBYD	—	(Note) H ₈	-1.0	0.0	1.0	GRYD	—	Color Difference Output DC Stepping	VBD	—	(Note) H ₉	-5	0.0	5	mV	VRD	—	1H Delay Quantity	BDt	—	(Note) H ₁₀	63.7	64.0	64.4	μ s	RDt	—	Color Difference Output	Bomin	—	(Note) H ₁₁	22	36	55	mV	DC-Offset Control	Bomax	—	-55		-36	-22	Bus-Min Data		Romin	—	22	36	55	Bus-Max Data	Romax		—	-55	-36	-22	Color Difference Output DC-Offset Control / Min. Control Quantity	Bo1	—	(Note) H ₁₂	1	4	8	Ro1	—	NTSC Mode Gain / NTSC-COM Gain	GNB	—	(Note) H ₁₃	-0.90	0	1.20	dB	GNR	—	0.92	0	1.58																	
Frequency Characteristic, Delay	GHB2	—	(Note) H ₅	-8.2	-6.5	-4.3																																																																																																																																
	GHR2	—						AC Gain, Direct	GBY1	—	(Note) H ₆	-2.0	-0.5	2.0		GRY1	—	AC Gain, Delay	GBY2	—	(Note) H ₇	-2.4	-0.5		1.1	GRY2	—	Direct-Delay AC Gain Difference	GBYD	—	(Note) H ₈	-1.0	0.0	1.0	GRYD	—	Color Difference Output DC Stepping	VBD	—	(Note) H ₉	-5	0.0	5	mV	VRD	—	1H Delay Quantity	BDt	—	(Note) H ₁₀	63.7	64.0	64.4	μ s	RDt	—	Color Difference Output	Bomin	—	(Note) H ₁₁	22	36	55	mV	DC-Offset Control	Bomax	—	-55	-36		-22	Bus-Min Data	Romin		—	22	36	55	Bus-Max Data	Romax	—	-55		-36	-22	Color Difference Output DC-Offset Control / Min. Control Quantity	Bo1	—	(Note) H ₁₂	1	4	8	Ro1	—	NTSC Mode Gain / NTSC-COM Gain	GNB	—	(Note) H ₁₃	-0.90	0	1.20	dB	GNR	—	0.92	0	1.58																											
AC Gain, Direct	GBY1	—	(Note) H ₆	-2.0	-0.5	2.0																																																																																																																																
	GRY1	—						AC Gain, Delay	GBY2	—	(Note) H ₇	-2.4	-0.5	1.1		GRY2	—	Direct-Delay AC Gain Difference	GBYD	—	(Note) H ₈	-1.0	0.0	1.0	GRYD	—	Color Difference Output DC Stepping	VBD	—	(Note) H ₉	-5	0.0	5	mV	VRD	—	1H Delay Quantity	BDt	—	(Note) H ₁₀	63.7	64.0	64.4	μ s	RDt	—	Color Difference Output	Bomin	—	(Note) H ₁₁	22	36	55	mV	DC-Offset Control	Bomax	—	-55	-36		-22	Bus-Min Data	Romin		—	22	36	55	Bus-Max Data	Romax	—	-55	-36		-22	Color Difference Output DC-Offset Control / Min. Control Quantity	Bo1	—	(Note) H ₁₂	1	4	8	Ro1	—	NTSC Mode Gain / NTSC-COM Gain	GNB	—	(Note) H ₁₃	-0.90	0	1.20	dB	GNR	—	0.92	0	1.58																																					
AC Gain, Delay	GBY2	—	(Note) H ₇	-2.4	-0.5	1.1																																																																																																																																
	GRY2	—						Direct-Delay AC Gain Difference	GBYD	—	(Note) H ₈	-1.0	0.0	1.0	GRYD	—	Color Difference Output DC Stepping	VBD	—	(Note) H ₉	-5	0.0	5	mV	VRD	—	1H Delay Quantity	BDt	—	(Note) H ₁₀	63.7	64.0	64.4	μ s	RDt	—	Color Difference Output	Bomin	—	(Note) H ₁₁	22	36	55	mV	DC-Offset Control	Bomax	—	-55	-36		-22	Bus-Min Data	Romin		—	22	36	55	Bus-Max Data	Romax	—	-55	-36		-22	Color Difference Output DC-Offset Control / Min. Control Quantity	Bo1	—	(Note) H ₁₂	1	4	8	Ro1	—	NTSC Mode Gain / NTSC-COM Gain	GNB	—	(Note) H ₁₃	-0.90	0	1.20	dB	GNR	—	0.92	0	1.58																																															
Direct-Delay AC Gain Difference	GBYD	—	(Note) H ₈	-1.0	0.0	1.0																																																																																																																																
	GRYD	—					Color Difference Output DC Stepping	VBD	—	(Note) H ₉	-5	0.0	5	mV	VRD	—	1H Delay Quantity	BDt	—	(Note) H ₁₀	63.7	64.0	64.4	μ s	RDt	—	Color Difference Output	Bomin	—	(Note) H ₁₁	22	36	55	mV	DC-Offset Control	Bomax	—	-55	-36		-22	Bus-Min Data	Romin		—	22	36	55	Bus-Max Data	Romax	—	-55	-36		-22	Color Difference Output DC-Offset Control / Min. Control Quantity	Bo1	—	(Note) H ₁₂	1	4	8	Ro1	—	NTSC Mode Gain / NTSC-COM Gain	GNB	—	(Note) H ₁₃	-0.90	0	1.20	dB	GNR	—	0.92	0	1.58																																																									
Color Difference Output DC Stepping	VBD	—	(Note) H ₉	-5	0.0	5		mV																																																																																																																														
	VRD	—					1H Delay Quantity		BDt	—	(Note) H ₁₀	63.7	64.0	64.4	μ s	RDt	—	Color Difference Output	Bomin	—	(Note) H ₁₁	22	36	55	mV	DC-Offset Control	Bomax	—	-55		-36	-22	Bus-Min Data		Romin	—	22	36	55	Bus-Max Data	Romax	—	-55		-36	-22	Color Difference Output DC-Offset Control / Min. Control Quantity	Bo1	—	(Note) H ₁₂	1	4	8	Ro1	—	NTSC Mode Gain / NTSC-COM Gain	GNB	—	(Note) H ₁₃	-0.90	0	1.20	dB	GNR	—	0.92	0	1.58																																																																		
1H Delay Quantity	BDt	—	(Note) H ₁₀	63.7	64.0	64.4		μ s																																																																																																																														
	RDt	—					Color Difference Output		Bomin	—	(Note) H ₁₁	22	36	55	mV	DC-Offset Control	Bomax	—	-55	-36		-22	Bus-Min Data	Romin		—	22	36	55	Bus-Max Data	Romax	—	-55		-36	-22	Color Difference Output DC-Offset Control / Min. Control Quantity	Bo1	—	(Note) H ₁₂	1	4	8	Ro1	—	NTSC Mode Gain / NTSC-COM Gain	GNB	—	(Note) H ₁₃	-0.90	0	1.20	dB	GNR	—	0.92	0	1.58																																																																												
Color Difference Output	Bomin	—	(Note) H ₁₁	22	36	55	mV																																																																																																																															
DC-Offset Control	Bomax	—		-55	-36	-22																																																																																																																																
Bus-Min Data	Romin	—		22	36	55																																																																																																																																
Bus-Max Data	Romax	—		-55	-36	-22																																																																																																																																
Color Difference Output DC-Offset Control / Min. Control Quantity	Bo1	—	(Note) H ₁₂	1	4	8																																																																																																																																
	Ro1	—						NTSC Mode Gain / NTSC-COM Gain	GNB	—	(Note) H ₁₃	-0.90	0	1.20	dB	GNR	—	0.92	0	1.58																																																																																																																		
NTSC Mode Gain / NTSC-COM Gain	GNB	—	(Note) H ₁₃	-0.90	0	1.20	dB																																																																																																																															
	GNR	—		0.92	0	1.58																																																																																																																																

Text section

CHARACTERISTIC	SYMBOL	TEST CIR-CUIT	TEST CONDITION	MIN.	TYP.	MAX.	UNIT
Y Color Difference Clamping Voltage	Vcp31	—	(Note) T ₁	1.7	2.0	2.3	V
	Vcp33	—		2.2	2.5	2.8	
	Vcp34	—					
Contrast Control Characteristic	Vc12mx	—	(Note) T ₂	2.50	3.00	3.50	
	Vc12mn	—		0.06	0.14	0.21	
	D12c80	—		0.83	1.24	1.86	
	Vc13mx	—		2.50	3.00	3.50	
	Vc13mn	—		0.06	0.14	0.21	
	D13c80	—		0.83	1.24	1.86	
	Vc14mx	—		2.50	3.00	3.50	
	Vc14mn	—		0.06	0.14	0.21	
AC Gain	Gr	—	(Note) T ₃	2.8	4.0	5.2	times
	Gg	—					
	Gb	—					
Frequency Characteristic	Gf	—	(Note) T ₄	—	-1.0	-3.0	dB
Y Sub-Contrast Control Characteristic	ΔV_{scnt}	—	(Note) T ₅	3.0	6.0	9.0	
Y ₂ Input Range	Vy2d	—	(Note) T ₆	0.7	—	—	
Unicolor Control Characteristic	Vn12mx	—	(Note) T ₇	1.6	2.3	4.3	V
	Vn12mn	—		0.05	0.12	0.19	
	D12n80	—		0.67	1.16	1.68	
	Vn14mx	—		1.6	2.3	4.3	
	Vn14mn	—		0.05	0.12	0.19	
	D14n80	—		0.67	1.16	1.68	
	ΔV_{14un}	—		22	27	32	dB
Relative Amplitude (NTSC)	Mnr-b	—	(Note) T ₈	0.70	0.77	0.85	times
	Mng-b	—		0.30	0.34	0.38	
Relative Phase (NTSC)	θ_{nr-b}	—	(Note) T ₉	87	93	99	°
	θ_{ng-b}	—		235	241.5	248	
Relative Amplitude (PAL)	Mpr-b	—	(Note) T ₁₀	0.50	0.56	0.63	times
	Mpg-b	—		0.30	0.34	0.38	
Relative Phase (PAL)	θ_{pr-b}	—	(Note) T ₁₁	86	90	94	°
	θ_{pg-b}	—		232	237	242	

CHARACTERISTIC	SYMBOL	TEST CIRCUIT	TEST CONDITION	MIN.	TYP.	MAX.	UNIT
Color Control Characteristic	Vcmx	—	(Note) T ₁₂	1.19	1.41	1.68	V _{p-p}
	e _{col}	—		80	128	160	step
	Δ _{col}	—		142	192	242	
Color Control Characteristic, Residual Color	e _{cr}	—	(Note) T ₁₃	0	12.5	25	mV _{p-p}
	e _{cg}	—					
	e _{cb}	—					
Chroma Input Range	V _{cr}	—	(Note) T ₁₄	700	—	—	
Brightness Control Characteristic	V _{brmx}	—	(Note) T ₁₅	3.05	3.45	3.85	V
	V _{brmn}	—		1.05	1.35	1.65	
Brightness Center Voltage	V _{bcnt}	—	(Note) T ₁₆	2.05	2.30	2.55	
Brightness Data Sensitivity	ΔV _{brt}	—	(Note) T ₁₇	6.3	7.8	9.4	mV
RGB Output Voltage Axes Difference	ΔV _{bct}	—	(Note) T ₁₈	-150	0	150	
White Peak Limit Level	V _{wpl}	—	(Note) T ₁₉	2.63	3.25	3.75	V
Cutoff Control Characteristic	V _{comx}	—	(Note) T ₂₀	2.55	2.75	2.95	
	V _{comn}	—		1.55	1.75	1.95	
Cutoff Center Level	V _{coct}	—	(Note) T ₂₁	2.05	2.3	2.55	
Cutoff Variable Range	ΔD _{cut}	—	(Note) T ₂₂	2.3	3.9	5.5	mV
Drive Variable Range	DR +	—	(Note) T ₂₃	2.7	3.85	5.0	dB
	DR -	—		-6.5	-5.6	-4.7	
DC Regeneration	TDC	—	(Note) T ₂₄	0	50	100	mV
RGB Output S/N Ratio	S _{No}	—	(Note) T ₂₅	—	-50	-45	dB
Blanking Pulse Output Level	V _v	—	(Note) T ₂₆	0.7	1.0	1.3	V
	V _h	—					
Blanking Pulse Delay Time	t _{don}	—	(Note) T ₂₇	0.05	0.25	0.45	μs
	t _{doff}	—		0.05	0.35	0.85	
RGB Min. Output Level	V _{mn}	—	(Note) T ₂₈	0.8	1.0	1.2	V
RGB Max. Output Level	V _{mx}	—	(Note) T ₂₉	6.85	7.15	7.45	
Halftone Ys Level	V _{thtl}	—	(Note) T ₃₀	0.7	0.9	1.1	
Halftone Gain	G _{6htl3}	—	(Note) T ₃₁	-7.5	-6.0	-4.5	dB
Text ON Ys Level	V _{ttxl}	—	(Note) T ₃₂	1.8	2.0	2.2	V
Text/OSD Output, Low Level	V _{txl13}	—	(Note) T ₃₃	-0.45	-0.25	-0.05	
Text RGB Output, High Level	V _{mt13}	—	(Note) T ₃₄	1.15	1.4	1.85	
OSD Ys ON Level	V _{tosl}	—	(Note) T ₃₅	2.8	3.0	3.2	
OSD RGB Output, High Level	V _{mos13}	—	(Note) T ₃₆	1.75	2.15	2.55	
Text Input Threshold Level	V _{txtg}	—	(Note) T ₃₇	0.7	1.0	1.3	
OSD Input Threshold Level	V _{osdg}	—	(Note) T ₃₈	1.7	2.0	2.3	

CHARACTERISTIC	SYMBOL	TEST CIRCUIT	TEST CONDITION	MIN.	TYP.	MAX.	UNIT
OSD Mode Switching Rise-Up Time	τ_{Rosr}	—	(Note) T ₃₉	—	40	100	ns
	τ_{Rosg}	—					
	τ_{Rosb}	—					
OSD Mode Switching Rise-Up Transfer Time	t_{PRosr}	—	(Note) T ₄₀	—	40	100	ns
	t_{PRosg}	—					
	t_{PRosb}	—					
OSD Mode Switching Rise-Up Transfer Time, 3 Axes Difference	Δt_{PRos}	—	(Note) T ₄₁	—	15	40	ns
OSD Mode Switching Breaking Time	τ_{Fosr}	—	(Note) T ₄₂	—	30	100	ns
	τ_{Fosg}	—					
	τ_{Fosb}	—					
OSD Mode Switching Breaking Transfer Time	t_{PFosr}	—	(Note) T ₄₃	—	30	100	ns
	t_{PFosg}	—					
	t_{PFosb}	—					
OSD Mode Switching Breaking Transfer Time, 3 Axes Difference	Δt_{FRos}	—	(Note) T ₄₄	—	20	40	ns
OSD Hi DC Switching Rise-Up Time	τ_{Roshr}	—	(Note) T ₄₅	—	20	100	ns
	τ_{Roshg}	—					
	τ_{Roshb}	—					
OSD Hi DC Switching Rise-Up Transfer Time	t_{PRohr}	—	(Note) T ₄₆	—	20	100	ns
	t_{PRohg}	—					
	t_{PRohb}	—					
OSD Hi DC Switching Rise-Up Transfer Time, 3 Axes Difference	Δt_{PRoh}	—	(Note) T ₄₇	—	0	40	ns
OSD Hi DC Switching Breaking Time	τ_{Foshr}	—	(Note) T ₄₈	—	20	100	ns
	τ_{Foshg}	—					
	τ_{Foshb}	—					
OSD Hi DC Switching Breaking Transfer Time	t_{PFohr}	—	(Note) T ₄₉	—	20	100	ns
	t_{PFohg}	—					
	t_{PFohb}	—					
OSD Hi DC Switching Breaking Transfer Time, 3 Axes Difference	Δt_{PFoh}	—	(Note) T ₅₀	—	0	40	ns

CHARACTERISTIC	SYMBOL	TEST CIRCUIT	TEST CONDITION	MIN.	TYP.	MAX.	UNIT
RGB Contrast Control Characteristic	Vc12mx	—	(Note) T ₅₁	2.10	2.5	2.97	V
	Vc12mn	—		0.05	0.12	0.19	
	D12c80	—		0.84	1.25	1.87	
	Vc13mx	—		2.10	2.5	2.97	
	Vc13mn	—		0.05	0.12	0.19	
	D13c80	—		0.84	1.25	1.87	
	Vc14mx	—		2.10	2.5	2.97	
	Vc14mn	—		0.05	0.12	0.19	
	D14c80	—		0.84	1.25	1.87	
Analog RGB AC Gain	Gag	—	(Note) T ₅₂	4.0	5.1	6.3	times
Analog RGB Frequency Characteristic	Gfg	—	(Note) T ₅₃	-0.5	-1.75	-3.0	dB
Analog RGB Dynamic Range	Dr24	—	(Note) T ₅₄	0.5	—	—	V
RGB Brightness Control Characteristic	Vbrmxg	—	(Note) T ₅₅	3.05	3.25	3.45	
	Vbrmng	—		1.05	1.25	1.45	
RGB Brightness Center Voltage	Vbcntg	—	(Note) T ₅₆	2.05	2.25	2.45	
RGB Brightness Data Sensitivity	$\Delta Vbrtg$	—	(Note) T ₅₇	6.3	7.8	9.4	mV
Analog RGB Mode ON Voltage	Vanath	—	(Note) T ₅₈	0.8	1.0	1.2	V
Analog RGB Switching Rise-Up Time	τ_{Ranr}	—	(Note) T ₅₉	—	50	100	ns
	τ_{Rang}	—					
	τ_{Ranb}	—					
Analog RGB Switching Rise-Up Transfer Time	t_{pRanr}	—	(Note) T ₆₀	—	20	100	
	t_{pRang}	—					
	t_{pRanb}	—					
Analog RGB Switching Rise-Up Transfer Time, 3 Axes Difference	Δt_{pRas}	—	(Note) T ₆₁	—	0	40	
Analog RGB Switching Breaking Time	τ_{Fanr}	—	(Note) T ₆₂	—	50	100	
	τ_{Fang}	—					
	τ_{Fanb}	—					
Analog RGB Switching Breaking Transfer Time	t_{pFanr}	—	(Note) T ₆₃	—	30	100	
	t_{pFang}	—					
	t_{pFanb}	—					
Analog RGB Switching Breaking Transfer Time, 3 Axes Difference	Δt_{pFas}	—	(Note) T ₆₄	—	0	40	

CHARACTERISTIC	SYMBOL	TEST CIRCUIT	TEST CONDITION	MIN.	TYP.	MAX.	UNIT
Analog RGB Hi Switching Rise-Up Time	τ_{Ranhr}	—	(Note) T ₆₅	—	50	100	ns
	τ_{Ranhg}	—					
	τ_{Ranhb}	—					
Analog RGB Hi Switching Rise-Up Transfer Time	t_{PRahr}	—	(Note) T ₆₆	—	20	100	
	t_{PRahg}	—					
	t_{PRahb}	—					
Analog RGB Hi Switching Rise-Up Transfer Time, 3 Axes Difference	Δt_{pRah}	—	(Note) T ₆₇	—	0	40	
Analog RGB Hi Switching Breaking Time	t_{Fanhr}	—	(Note) T ₆₈	—	50	100	
	t_{Fanhg}	—					
	t_{Fanhb}	—					
Analog RGB Hi Switching Breaking Transfer Time	t_{PFahr}	—	(Note) T ₆₉	—	20	100	
	t_{PFahg}	—					
	t_{PFahb}	—					
Analog RGB Hi Switching Breaking Transfer Time, 3 Axes Difference	Δt_{pFah}	—	(Note) T ₇₀	—	0	40	
TV-Analog RGB Crosstalk	Crtvag	—	(Note) T ₇₁	- 80	- 50	- 40	dB
Analog RGB-TV Crosstalk	Crantg	—	(Note) T ₇₂				
ABL Point Characteristic	Vablpl	—	(Note) T ₇₃	5.5	5.6	5.7	V
	Vablpc	—		5.7	5.8	5.9	
	Vablph	—		5.9	6.0	6.1	
ACL Characteristic	Vcal	—	(Note) T ₇₄	- 19	- 16	- 13	dB
ABL Gain Characteristic	Vabll	—	(Note) T ₇₅	- 0.3	0	0.3	V
	Vablc	—		- 1.3	- 1.0	- 0.7	
	Vablh	—		- 2.3	- 2.0	- 1.7	

SECAM section

CHARACTERISTIC	SYMBOL	TEST CIRCUIT	TEST CONDITION	MIN.	TYP.	MIN.	UNIT
Bell Monitor Output Amplitude	embo	—	(Note) S ₁	200	300	400	mV _{p-p}
Bell Filter f ₀	foB-C	—	(Note) S ₂	-23	0	23	kHz
Bell Filter f ₀ Variable Range	foB-L	—	(Note) S ₃	-69	-46	-23	
	foB-H	—		69	92	115	
Bell Filter Q	QBEL	—	(Note) S ₄	14	16	18	—
Color Difference Output Amplitude	VBS	—	(Note) S ₅	0.50	—	0.91	V _{p-p}
	VRS	—		0.39	—	0.73	
Color Difference Relative Amplitude	R / B-S	—	(Note) S ₆	0.70	—	0.90	—
Color Difference Attenuation Quantity	SATTB	—	(Note) S ₇	-1.50	—	-0.50	dB
	SATTR	—					
Color Difference S / N Ratio	SNB-S	—	(Note) S ₈	-85	—	-25	
	SBR-S	—					
Linearity	LinB	—	(Note) S ₉	75	—	117	%
	LinR	—		85	—	120	
Rising-Fall Time (Standard De-Emphasis)	trfB	—	(Note) S ₁₀	—	1.3	1.5	μs
	trfR	—					
Rising-Fall Time (Wide-Band De-Emphasis)	trfBw	—	(Note) S ₁₁	—	1.1	1.3	
	trfRw	—					
Killer Operation Input Level (Standard Setting)	eSK	—	(Note) S ₁₂	0.5	1	2	mV _{p-p}
	eSC	—					
Killer Operation Input Level (VID ON)	eSFK	—	(Note) S ₁₃				
	eSFC	—					
Killer Operation Input Level (Low Sensitivity, VID OFF)	eSWK	—	(Note) S ₁₄	0.7	1.5	3	
	eSWC	—					

TEST CONDITION
VIDEO SECTION

NOTE	ITEM	TEST CONDITION (Unless otherwise specified : H, RGB V _{CC} = 9V ; V _{DD} , Fsc V _{DD} , Y/C V _{CC} = 5V ; Ta = 25 ± 3°C)					MEASURING METHOD	
		SW MODE		SUB-ADDRESS & BUS DATA				
		S39	S42	S44	S45	S51	04H 08H 0FH 10H 13H 14H	
Y1	Y Input Pedestal Clamping Voltage	A	C	B	A	A	20H 04H 80H 00H 3AH 03H	(1) Short circuit pin 45 (Y ₁ IN) in AC coupling. (2) Input synchronizing signal to pin 48 (SYNC IN). (3) Measure DC voltage at pin 45, and express the measurement result as VYclp.
Y2	Chroma Trap Frequency	↑	↑	A	B	↑	↑	(1) Set the 358 TRAP mode to AUTO by setting the bus data. (2) Set the bus data so that chroma trap is ON and f ₀ is 0. (3) Input TG7 sine wave signal whose frequency is 3.58 MHz (NTSC) and video amplitude is 0.5 V to pin 45 (Y ₁ IN). (4) While observing waveform at pin 37 (Y _{1out}), find a frequency with minimum amplitude of the waveform. The obtained frequency shall be expressed as flr3. (5) Change the frequency of the signal 1 to 4.43 MHz (PAL) and perform the same measurement as the preceding step 4. The obtained frequency shall be expressed as flr4.
Y3	Chroma Trap Attenuation (3.58 MHz)	↑	↑	↑	↑	↑	↑	(1) Set the bus data so that Q of chroma trap is 1.5. (2) Set the bus data so that f ₀ of chroma trap is 0. (3) Input TG7 sine wave signal whose frequency is 3.58 MHz (NTSC) and video amplitude is 0.5 V to pin 45 (Y ₁ IN). (4) While turning on and off the chroma trap by controlling the bus, measure chroma amplitude (V _{Ton}) at pin 37 (Y _{1out}) with the chroma trap being turned on and measure chroma amplitude (V _{Toff}) at pin 37 (Y _{1out}) with the chroma trap being turned off. Gtr = 20 log (V _{Toff} /V _{Ton}) (5) Change f ₀ of the chroma trap to -100 kHz, -50 kHz, 0 and +50 kHz, and perform the same measurement as the preceding steps 4 and 5 with the respective f ₀ settings. (6) Change Q of the chroma trap to 1, 1.5, 2 and 2.5, and perform the same measurement as the preceding steps 4 through 6. The maximum Gtr shall be expressed as Gtr3a.

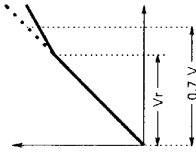
NOTE	ITEM	TEST CONDITION (Unless otherwise specified : H, RGB VCC = 9V ; VDD, Fsc VDD, Y/C VCC = 5V ; Ta = 25 ± 3°C)												
		SW MODE			SUB-ADDRESS & BUS DATA									
		S39	S42	S44	S45	S51	04H 08H 0FH 10H 13H 14H	MEASURING METHOD						
Y4	Chroma Trap Attenuation (4.43 MHz)	A	C	A	B	A	20H 04H	Variable						(1) Set the S-D-Trap is ON. (2) Set the bus data so that Q of chroma trap is 1.5. (3) Set the bus data so that fg of chroma trap is 0. (4) Input TG7 sine wave signal whose frequency is 4.43 MHz and video amplitude is 0.5V to pin 45 (Y1 IN). (5) Perform the same measurement as the steps 4 through 6 of the preceding item Y3. The measurement result shall be expressed as Gtr4.
Y5	Chroma Trap Attenuation (SECAM)	↑	↑	↑	↑	↑	↑	↑	↑	↑	↑	↑	(1) Set the Dtrap is ON. (2) Set the bus data so that Q of chroma trap is 1.5. (3) Set the bus data so that fg of chroma trap is 0. (4) Input SECAM signal whose amplitude in video period is 0.5V to pin 45 (Y1 IN). (5) Perform the same measurement as the steps 5 through 7 of the preceding item Y3 to find the maximum attenuation (Gtrs).	
Y6	Yγ Correction Point	↑	↑	↑	↑	↑	↑	Variable	80H	↑	3AH	↑	(1) Connect the power supply to pin 45 (Y1 IN). (2) Turn off Yγ by setting the bus data. (3) While raising the supply voltage from the level measured in the preceding item Y1, measure voltage change characteristic of Y1 output at pin 37. (4) Set the bus data to turn on Yγ above step 3. (6) Find a gamma (γ) point from the measurement results of the steps 3 and 5. $\gamma p = Vr \div 0.7 V$ 	
Y7	Yγ Correction Curve	↑	↑	↑	↑	↑	↑	↑	↑	↑	↑	↑	From the measurement in the above item Y6, find gain of the portion that the γ correction has an effect on.	

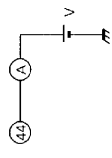
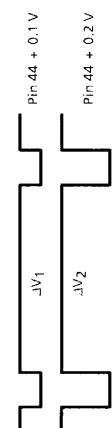
NOTE	ITEM	TEST CONDITION (Unless otherwise specified : H, RGB VCC = 9 V ; VDD, Fsc VDD, Y/C VCC = 5 V ; Ta = 25 ± 3°C)				SW MODE	SUB-ADDRESS & BUS DATA				MEASURING METHOD	
		S39	S42	S44	S45		S51	04H 08H 0FH 10H 13H 14H				
Y8	APL Terminal Output Impedance	A	C	B	A							<p>(1) Short circuit pin 45 (Y₁ IN) in AC coupling.</p> <p>(2) Input synchronizing signal to pin 51.</p> <p>(3) Connect power supply and an ammeter to the APL of pin 44 as shown in the figure, and adjust the power supply so that the ammeter reads 0 (zero).</p> <p>(4) Raise the voltage at pin 44 by 0.1 V, and measure the current (I_{in}) at that time.</p> <p>Zo44 (Ω) = 0.1 V ÷ I_{in} (A)</p> 
Y9	DC Transmission Compensation Amplifier Gain											<p>(1) Set the bus data so that DC transmission factor correction gain is maximum.</p> <p>(2) In the condition of the Note Y₈, observe Y_{1out} waveform at pin 37 and measure voltage change in the video period.</p> <p>(3) Set the bus data so that DC transmission factor correction gain is centered, and measure voltage in the same manner as the above step 2.</p>  <p>Ad_r = (ΔV₂ - ΔV₁) ÷ 0.1 V ÷ Y₁ gain</p>
Y10	Maximum Gain of Black Expansion Amplifier											<p>(1) Set the bus data so that black expansion is on and black expansion point is maximum.</p> <p>(2) Input TG7 sine wave signal whose frequency is 500 kHz and video amplitude is 0.1 V to pin 45 (Y₁ IN).</p> <p>(3) While impressing 1.0 V to pin 39 (Black Peak Hold), measure amplitude (V_a) of Y_{1out} signal at pin 37.</p> <p>(4) While impressing 3.5 V to pin 39 (Black Peak Hold), measure amplitude (V_b) of Y_{1out} signal at pin 37.</p> <p>Ak_c = V_a ÷ V_b</p>

NOTE	ITEM	TEST CONDITION (Unless otherwise specified : H, RGB V _{CC} = 9 V ; V _{DD} , Fsc V _{DD} , Y/C V _{CC} = 5 V ; Ta = 25 ± 3°C)					MEASURING METHOD
		SW MODE		SUB-ADDRESS & BUS DATA			
		S39	S42	S44	S45	S51	04H 08H 0FH 10H 13H 14H
Y11	Black Expansion Start Point	A	C	A	A	A	20H 04H 00H 00H 3AH Variable
Y12	Black Peak Detection Period (Horizontal) Black Peak Detection Period (Vertical)	B	↑	↑	↑	↑	↑

(1) Set the bus data so that black expansion is on and black expansion point is maximum.
 (2) Supply 1.0 V to pin 39 (Black Peak Hold).
 (3) Supply 2.9 V to the APL of pin 44.
 (4) Connect the power supply to pin 45 (Y₁ IN). While raising the supply voltage from the level measured in the preceding item Y₁, measure voltage change at pin 37 (Y₁out).
 (5) Set the bus data to center the black expansion point, and perform the same measurement as the above steps 2 through 4.
 (6) Set the black expansion point to the minimum by setting the bus data, and perform the same measurement as the above steps 2 through 4.
 (7) While supplying 2.2 V to the APL of pin 44, perform the same measurement as the above step 4 with the black expansion point set to maximum, center and minimum.

In the condition of the Note Y₁, measure waveform at pin 39 (Black Peak Hold).

NOTE	ITEM	TEST CONDITION (Unless otherwise specified : H, RGB V _{CC} = 9 V ; V _{DD} , Fsc V _{DD} , Y/C V _{CC} = 5 V ; Ta = 25 ± 3°C)											
		SW MODE					SUB-ADDRESS & BUS DATA					MEASURING METHOD	
		S39	S42	S44	S45	S51	04H	08H	0FH	10H	13H		14H
Y13	Picture Quality Control Peaking Frequency	A	C	A	B	A	3FH	04H	80H	00H	3AH	Variable	<p>(1) Set the bus data so that picture quality control frequency is 2.5 MHz.</p> <p>(2) Input TG7 sine wave (sweeper) signal whose video level is 0.1 V to pin 45 (Y₁ IN) and pin 51 (Sync. IN).</p> <p>(3) Maximize the picture quality control data.</p> <p>(4) While observing Y₁out of pin 37, find an SG frequency as the waveform amplitude is maximum (fp25).</p> <p>(5) Set the bus data so that picture quality control frequency is 3.1 MHz and 4.2 MHz, and perform the same measurement as the above steps 2 through 4 at the respective frequencies (fp31, fp42).</p>
Y14	Picture Quality Control Maximum Characteristic	↑	↑	↑	↑	↑	↑	↑	↑	↑	↑	↑	<p>(1) Input TG7 sine wave (sweeper) signal whose video level is 0.1 V to pin 45 (Y₁ IN) and pin 48 (Sync. IN).</p> <p>(2) Set the picture quality control data to maximum.</p> <p>(3) Set the picture quality control frequency is 2.5 MHz by setting the bus data.</p> <p>(4) Measure amplitude (V100k) of the output of pin 37 (Y₁ OUT) as the SG frequency is 100 kHz, and the amplitude (Vp25) of the same as the SG frequency is 2.5 MHz. GS25MX = 20 log (Vp25 / V100k)</p> <p>(5) Set the picture quality control frequency data to 3.1 MHz by setting the bus data.</p> <p>(6) Measure amplitude (V100k) of the output of pin 37 (Y₁ OUT) as the SG frequency is 100 kHz, and the amplitude (Vp31) of the same as the SG frequency is 3.1 MHz. GS31MX = 20 log (Vp31 / V100k)</p> <p>(7) Set the picture quality control frequency to 4.2 MHz by setting the bus data.</p> <p>(8) Measure amplitude (V100k) of the output of pin 37 (Y₁ OUT) as the SG frequency is 100 kHz, and the amplitude (Vp42) of the same as the SG frequency is 4.2 MHz. GS42MX = 20 log (Vp42 / V100k)</p>

NOTE	ITEM	TEST CONDITION (Unless otherwise specified : H, RGB V _{CC} = 9V ; V _{DD} , Fsc V _{DD} , Y/C V _{CC} = 5V ; Ta = 25 ± 3°C)					SUB-ADDRESS & BUS DATA	MEASURING METHOD
		SW MODE	S44	S45	S51	S42		
Y15	Picture Quality Control Minimum Characteristic	A	C	A	B	A	04H 08H 0FH 10H 13H 14H	(1) In the condition of the Note Y14, set the picture quality control bus data to minimum. (2) Perform the same measurement as the steps 3 through 8 of the Note Y14 to find respective gains as the picture quality control frequency is set to 2.5 MHz, 3.1 MHz and 4.2 MHz. GS25MN = 20 flog (Vp25/V100k) GS31MN = 20 flog (Vp31/V100k) GS42MN = 20 flog (Vp42/V100k)
Y16	Picture Quality Control Center Characteristic	↑	↑	↑	↑	↑	20H	(1) In the condition of the Note Y14, set the picture quality control bus data to center. (2) Perform the same measurement as the steps 3 through 8 of the Note Y14 to find respective gains as the picture quality control frequency is set to 2.5 MHz, 3.1 MHz and 4.2 MHz. GS25CT = 20 flog (Vp25/V100k) GS31CT = 20 flog (Vp31/V100k) GS42CT = 20 flog (Vp42/V100k)
Y17	Y Signal Gain	↑	↑	↑	↑	↑	03H	(1) Set the bus data so that black expansion is off, picture quality control is off and DC transmission compensation is minimum. (2) Input TG7 sine wave signal whose frequency is 100 kHz and video level is 0.5V to pin 45 (Y1 IN) and pin 48 (Sync. IN). (Vy1100) (3) Measure amplitude of Y1 output at pin 37 (Yout). Gy = 20 flog (Yout/Vy1100)
Y18	Y Signal Frequency Characteristic	↑	↑	↑	↑	↑	↑	(1) Set the bus data so that black expansion is off, picture quality control is off and DC transmission compensation is minimum. (2) Input TG7 sine wave signal whose frequency is 6 MHz and video level is 0.5V to pin 45 (Y1 IN) and pin 48 (Sync. IN). (Vy16M) (3) Measure amplitude of Y1 output at pin 37 (Yyo6M). Gy6M = 20 flog (Yyo6M/Vy16M) (4) Find Gfy from the result of the Note Y17. Gfy = Gy6M - Gy

NOTE	ITEM	TEST CONDITION (Unless otherwise specified : H, RGB V _{CC} = 9V ; V _{DD} , Fsc V _{DD} , Y/C V _{CC} = 5V ; Ta = 25 ± 3°C)						
		SW MODE	SUB-ADDRESS & BUS DATA					
		S39	S42	S44	S45	S51	04H 08H 0FH 10H 13H 14H	MEASURING METHOD
Y19	Y Signal Maximum Input Range	A	C	A	B	A	20H 04H 80H 00H 3AH 03H	(1) Set the bus data so that black expansion is off, picture quality control is off and DC transmission compensation is minimum. (2) Input TG7 sine wave signal whose frequency is 100 kHz to pin 45 (Y ₁ IN) and pin 48 (Sync. IN). (3) While increasing the amplitude V _{yd} of the signal in the video period, measure V _{yd} just before the waveform of Y ₁ output (pin 37) is distorted.

NOTE		TEST CONDITION (Unless otherwise specified : H, RGB V _{CC} = 9 V ; V _{DD} , Fsc V _{DD} , Y/C V _{CC} = 5 V ; Ta = 25 ± 3°C)									
		S26	S1	S31	S33	S34	S39	S42	S44	S45	S51
ITEM		MEASURING METHOD									
C2	Band Pass Filter Characteristic	ON	A	B	B	B	A	B	A	A	B

(1) Activate the test mode (S26-ON, Sub Add 02 ; 01h).
 (2) Set as follows : band pass filter Q = 2, crystal clock = conforming to 3.579 / 4.43 MHz, gate = normal status.
 (3) Input 3N composite sine wave signal (1 V_{p-p}) to pin 42 (Chroma IN).
 (4) Measure frequency characteristic of B-Y output of pin 36 and measure the peak frequency, too.
 (5) Changing f₀ to 0, 500, 600 and 700 by the bus control and measure peak frequencies respectively with different f₀.
 (6) For measuring frequency characteristic as f₀ is 4.43, use 4.43 MHz crystal clock.

Measure the following items in the same manner.

TEST CONDITION (Unless otherwise specified : H, RGB V _{CC} = 9 V ; V _{DD} , Fsc V _{DD} , Y/C V _{CC} = 5 V ; Ta = 25 ± 3°C)																						
NOTE	ITEM	MEASURING METHOD																				
		S26	S1	S31	S33	S34	S39	S42	S44	S45	S51											
C3	Band Pass Filter, -3 dB Band Characteristic																					
		ON	A	B	B	B	A	B	A	A	B											
C4	Band Pass Filter, Q Characteristic Check																					

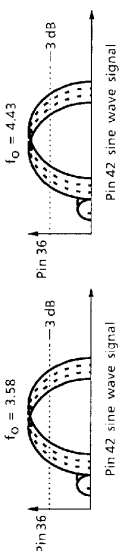
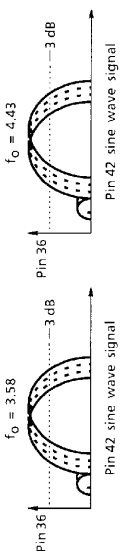

NOTE	ITEM	TEST CONDITION (Unless otherwise specified : H, RGB V _{CC} = 9 V ; V _{DD} , Fsc V _{DD} , Y/C V _{CC} = 5 V ; Ta = 25 ± 3°C)									
		MEASURING METHOD									
		S26	S1	S31	S33	S34	S39	S42	S44	S45	S51
											(1) Activate the test mode (S26-ON, Sub Add 02 ; 01h). (2) Set as follows : band pass filter Q = 2, crystal clock = conforming to 3.579 / 4.43 MHz, gate = normal status. (3) Input 3N composite sine wave signal (1 V _{p-p}) to pin 42 (Chroma IN). (4) Measure frequency characteristic of B-Y output of pin 36, and measure bottom frequency. (5) Changing f ₀ to 0, 500, 600 and 700 by the bus control and measure bottom frequencies respectively with different f ₀ .
C5	1/2 f ₀ Trap Characteristic	ON	A	B	B	B	A	B	A	A	B

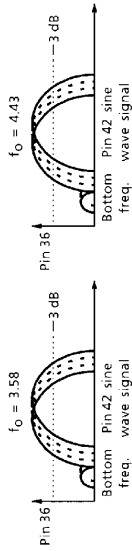

NOTE		TEST CONDITION (Unless otherwise specified : H, RGB V _{CC} = 9 V ; V _{DD} , Fsc V _{DD} , Y/C V _{CC} = 5 V ; Ta = 25 ± 3°C)									
		MEASURING METHOD									
ITEM		S26	S1	S31	S33	S34	S39	S42	S44	S45	S51
C6	Tint Control Sharing Range (f ₀ = 600 kHz)	ON	A	B	B	B	A	A	A	A	B
C7	Tint Control Variable Range (f ₀ = 600 kHz)	↑	↑	↑	↑	↑	↑	↑	↑	↑	↑
C8	Tint Control Characteristic	↑	↑	↑	↑	↑	↑	↑	↑	↑	↑

(1) Activate the test mode (S26-ON, Sub Add 02 ; 08h).

(2) Connect band pass filter (Q = 2), set crystal mode to conform to European, Asian system and set the gate to normal status.

(3) Input 3N rainbow color bar signal (100 mV_{p-p}) to pin 42 (Chroma IN).

(4) Measure phase shift of B-Y color difference output of pin 36.

(5) While shifting color phase (tint) from minimum to maximum by the bus control, measure phase change of B-Y color difference output of pin 36. On the condition that 6 bars in the center have the peak level (regarded as center of color phase), the side of 5 bars is regarded as positive direction while the side of 7 bars is regarded as negative direction when the 5 bars or the 7 bars are in the peak level. Based on this assumption, open angle toward the positive direction is expressed as $\Delta\theta_1$ and that toward the negative direction is expressed as $\Delta\theta_2$ as viewed from the phase center. $\Delta\theta_1$ and $\Delta\theta_2$ show the tint control sharing range.

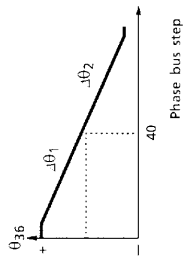

(6) Variable range is expressed by sum of $\Delta\theta_1$ sharing range and $\Delta\theta_2$ sharing range.
 $\Delta\theta_T = \Delta\theta_1 + \Delta\theta_2$

(7) While shifting color phase from minimum to maximum with the bus control, measure phase shift of B-Y color difference output of pin 36. When center 6 bars have peak level, value of color phase bus step is expressed as θ_{Tin} .

(8) While shifting color phase from minimum to maximum with the bus control, measure values of color phase bus step corresponding to 10% and 90% of absolutely variable phase shift of B-Y color difference output of pin 36. The range of color phase shifted by the bus control is expressed as While shifting color phase from minimum to maximum with the bus control, measure phase shift of B-Y color difference output of pin 36.

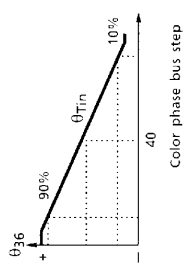

When center 6 bars have peak level, value of color phase bus step is expressed as θ_{Tin} (conforming to TV mode, f₀ = 600 kHz).

(9) Input 4N rainbow color bar signal to pin 42 (Chroma IN), and perform the same measurement as the 3N signal.

NOTE	ITEM	TEST CONDITION (Unless otherwise specified : H, RGB V _{CC} = 9V ; V _{DD} , Fsc V _{DD} , Y/C V _{CC} = 5V ; Ta = 25 ± 3°C)									
		MEASURING METHOD									
		SW MODE									
		S26	S1	S31	S33	S34	S39	S42	S44	S45	S51
											(1) Connect band pass filter (Q = 2), set to TV mode (f ₀ = 600 kHz) with X'tal clock conforming to European, Asian system. (2) Set the gate to normal status. (3) Input 3N CW signal of 100 mV _{p-p} to pin 42 of the chroma input terminal. (4) While changing frequency of the CW (continuous waveform) signal, measure its frequency when B-Y color difference signal of pin 36 is colored. (5) Input 4N CW (continuous waveform) 100 mV _{p-p} signal to pin 42 (Chroma IN). (6) While changing frequency of the CW signal, measure frequencies when B-Y color difference output of pin 36 is colored and discolored. Find difference between the measured frequency and f _c (4.433619 MHz) and express the differences as fPH and fPL, which show the APC lead-in range. (7) Variable frequency of VCXO is used to cope with lead-in of 3.582 MHz / 3.575 MHz PAL system. (8) Activate the test mode (S26-ON, Sub Add 02 ; 02h). (9) Input nothing to pin 42 (Chroma IN). (10) While varying voltage of pin 30 (APC Filter), measure variable frequency of VCXO at pin 35 (R-Y OUT) while observing color and discoloring of R-Y color difference signal. Express difference between the high frequency (fH) and f ₀ center as 3.582HH, and difference between the low frequency (fL) and f ₀ center as 3.582HL. Perform the same measurement for the NP system (3.575 MHz PAL).
C9	APC Lead-In Range	OFF ↓ ON	A	B	B	B	A	A	A	A	B
C10	APC Control Sensitivity	ON	↑	↑	↑	↑	↑	C	↑	↑	↑
											(1) Activate the test mode (S26-ON, Sub Add 02 ; 02h). (2) Connect band pass filter as same as the Note C9. (3) Change the X'tal mode properly to the system. (4) Input nothing to pin 42 (Chroma IN). (5) When V ₃₀ 's APC voltage ±50 mV is impressed to pin 30 (APC Filter) while its voltage is being varied, measure frequency change of pin 35 output signal as frH or frL and calculate sensitivity according to the following equation. $b = (frH - frL) / 100$

NOTE	ITEM	TEST CONDITION (Unless otherwise specified : H, RGB V _{CC} = 9 V ; V _{DD} , Fsc V _{DD} , Y/C V _{CC} = 5 V ; Ta = 25 ± 3°C)										
		SW MODE					MEASURING METHOD					
		S26	S1	S31	S33	S34	S39	S42	S44	S45	S51	
												(1) Connect band pass filter (Q = 2) and set to TV mode (f ₀ = 600 kHz). (2) Set the crystal mode to conform to European, Asian system and set the gate to normal status. (3) Input 3N color signal having 200 mV _{p-p} burst to pin 42 (Chroma IN). (4) While attenuating chroma input signal, measure input burst amplitudes of the signal when B-Y color difference output of pin 36 is discolored and when the same signal is colored. Measured input burst amplitudes shall be expressed as 3N-VTK1 and 3N-VTC1 respectively (killer operation input level). (5) Killer operation input level in the condition that P/N killer sensitivity is set to LOW with the bus control is expressed as 3N-VTK2 or 3N-VTC2. (6) Perform the same measurement as the above step 4 with different inputs of 4N, 4P, MP, NP color signals having 200 mV _{p-p} burst to pin 42 (Chroma IN). (When measuring with MP/NP color signal, set the crystal system to conform to South American system.) (7) Killer operation input level at that time is expressed as follows. Normal killer operation input level in the 4N system is expressed as 4N-VTK1, 4N-VTC1. Normal killer operation input level in the 4P system is expressed as 4P-VTK1, 4P-VTC1. Killer operation input level with low killer sensitivity is expressed as 4P-VTK2, 4P-VTC2. Normal killer operation input level in the MP system is expressed as MP-VTK2, MP-VTC2. Normal killer operation input level in the NP system is expressed as NP-VTK1, NP-VTC1. Killer operation input level with low killer sensitivity is expressed as NP-VTK2, NP-VTC2. [Reference] 3N system : 3.579545 MHz NTSC 4N system : 4.433619 MHz False NTSC 4P system : 4.433619 MHz PAL MP system : 3.575611 MHz M-PAL NP system : 3.582056 MHz N-PAL
C11	Killer Operation Input Level	OFF	A	B	B	B	A	A	A	A	B	

NOTE	ITEM	TEST CONDITION (Unless otherwise specified : H, RGB V _{CC} = 9V ; V _{DD} , Fsc V _{DD} , Y/C V _{CC} = 5V ; Ta = 25 ± 3°C)										
		MEASURING METHOD										
		S26	S1	S31	S33	S34	S39	S42	S44	S45	S51	
C12	Color Difference Output	ON	A	B	B	B	A	A	A	A	B	<p>(1) Activate the test mode (S26-ON, Sub Add 02 ; 08h).</p> <p>(2) Connect band pass filter (Q = 2), set to TV mode (f₀ = 600 kHz) with 0dB attenuation.</p> <p>(3) Set the crystal mode to conform to European, Asian system and set the gate to normal status.</p> <p>(4) Input 3N, 4N and 4P rainbow color bar signals having 100 mV_{p-p} burst to pin 42 of the chroma input terminal one after another.</p> <p>(5) Measure amplitudes of color difference signals of pin 36 (B-Y) and pin 35 (R-Y) respectively, and express them as 3NeB-Y/R-Y, 4NeB-Y/R-Y and 4PeB-Y/R-Y respectively.</p> <p>(6) While inputting 4P 75% color bar signal (100 mV_{p-p} burst) to pin 42 of the chroma input terminal, measure amplitudes of color difference signals of pin 36 (B-Y OUT) and pin 35 (R-Y OUT) respectively. (Ratio of those amplitudes is expressed as 4PeB-y/r-y for checking color level of SECAM system.)</p>
C13	Demodulation Relative Amplitude											<p>(1) Activate the test mode (S26-ON, Sub Add 02 ; 08h).</p> <p>(2) Connect band pass filter (Q = 2), set to TV mode (f₀ = 600 kHz) with 0dB attenuation.</p> <p>(3) Set the crystal mode to conform to European, Asian system and set the gate to normal status.</p> <p>(4) Input 3N, 4N and 4P rainbow color bar signals having 100 mV_{p-p} burst to pin 42 of the chroma input terminal one after another.</p> <p>(5) Measure amplitudes of color difference signals of pin 36 (B-Y) and pin 35 (R-Y) respectively, and express ratio between the two amplitudes as 3NG R/B, 4NG R/B and 4PG R/B respectively.</p> <p>(Note) Relative amplitude of G-Y color difference signal shall be checked later in the Text section.</p>

NOTE		TEST CONDITION (Unless otherwise specified : H, RGB V _{CC} = 9 V ; V _{DD} , Fsc V _{DD} , Y/C V _{CC} = 5 V ; Ta = 25 ± 3°C)										
		MEASURING METHOD										
ITEM	SW MODE											
	S26	S1	S31	S33	S34	S39	S42	S44	S45	S51		
C14	Demodulation Relative Phase	ON	A	B	B	A	A	A	A	B		
C15	Demodulation Output Residual Carrier	↑	↑	↑	↑	↑	↑	↑	↑	↑		

(1) Activate the test mode (S26-ON, Sub Add 02 ; 08h).
 (2) Connect band pass filter (Q = 2), set to TV mode (f_o = 600 kHz) with 0 dB attenuation.
 (3) Set the crystal mode to conform to European, Asian system and set the gate to normal status.
 (4) Input 3N, 4N and 4P rainbow color bar signals having 100 mV_{p-p} burst to pin 42 of the chroma input terminal one after another.
 (5) Measure phases of color difference signals of pin 36 (B-Y) and pin 35 (R-Y) respectively, and express them as 3NθR-B, 4NθR-B and 4PθR-B respectively.
 (6) For measuring with 3N and 4N color bar signals in NTSC system, set six bars of the B-Y color difference waveform to the peak level with the Tint control and measure its phase difference from phase of R-Y color difference signal of pin 35 (R-Y OUT).
 (Note) Relative phase of G-Y color difference signal shall be checked later in the Text section.

(1) Activate the test mode (S26-ON, Sub Add 02 ; 08h).
 (2) Connect band pass filter (Q = 2), set to TV mode (f_o = 600 kHz) with 0 dB attenuation.
 (3) Set the crystal mode to conform to European, Asian system.
 (4) Set the gate to normal status.
 (5) Input 3N and 4N rainbow color bar signals having 100 mV_{p-p} burst to pin 42 of the chroma input terminal one after another.
 (6) Measure subcarrier leak of 3N and 4N color bar signals appearing in color difference signals of pin 36 (B-Y OUT) and pin 35 (R-Y OUT) respectively, and express those leaks as 3N-SCB/R and 4N-SCB/R.

TEST CONDITION (Unless otherwise specified : H, RGB V _{CC} = 9V ; V _{DD} , Fsc V _{DD} , Y/C V _{CC} = 5V ; Ta = 25 ± 3°C)													
NOTE	ITEM	SW MODE											
		S26	S1	S31	S33	S34	S39	S42	S44	S45	S51		
MEASURING METHOD													
C16	Demodulation Output Residual Higher Harmonic	ON	A	B	B	B	A	A	A	A	B	B	<ol style="list-style-type: none"> (1) Activate the test mode (S26-ON, Sub Add 02 ; 08h). (2) Connect band pass filter (Q = 2), set to TV mode (f_o = 600 kHz) with 0 dB attenuation. (3) Set the crystal mode to conform to European, Asian system and set the gate to normal status. (4) Input 3N and 4N rainbow color bar signals having 100 mV_{p-p} burst to pin 42 of the chroma input terminal one after another. (5) Measure higher harmonic (2f_c = 7.16 MHz or 8.87 MHz) of 3N and 4N color bar signals appearing in color difference signals of pin 36 (B-Y OUT) and pin 35 (R-Y OUT) respectively, and express them as 3N-HCB/R and 4N-HCB/R.
C17	Color Difference Output ATT Check	↑	↑	↑	↑	↑	↑	↑	↑	↑	↑	<ol style="list-style-type: none"> (1) Activate the test mode (S26-ON, Sub Add 02 ; 08h). (2) Connect band pass filter (Q = 2) and set bus data for the TV mode (f_o = 600 kHz). (3) Set the X'tal clock mode to conform to European, Asian system and set the gate to normal status. (4) Input 3N rainbow color bar signal whose burst is 100 mV_{p-p} to pin 42 of the chroma input terminal. (5) Measure amplitude of color difference output signal of pin 36 (B-Y OUT) with 0 dB attenuation set by the bus control. Set the amplitude of the color difference output of pin 36 (B-Y OUT) to 0 dB, and measure amplitude of the same signal with different attenuation of -2 dB, -1 dB and +1 dB set by the bus control. 	

NOTE	ITEM	TEST CONDITION (Unless otherwise specified : H, RGB V _{CC} = 9V ; V _{DD} , f _{sc} V _{DD} , Y/C V _{CC} = 5V ; Ta = 25 ± 3°C)																MEASURING METHOD	
		S	BUS : TEST MODE				BUS : NORMAL CONTROL MODE				OTHER CONDITION								
			02H		07H		10H												
		D5	D2	D1	D0	D7	D4	D3	D3	D5	D4	D3	D2	D1	D0				
C18	16.2 MHz Oscillation Frequency	ON	0	0	0	1	0	0	0	0	0	0	0	0	0	0	(1) Input nothing to pin 42. (2) Measure frequency of CW signal of pin 35 as fr, and find oscillation frequency by the following equation. $\Delta f_{of} = (fr - 0.05 \text{ MHz}) \times 4$		
C19	16.2 MHz Oscillation Start Voltage	ON	0	0	0	1	0	0	0	0	0	0	0	0	0	0	While raising voltage of pin 38, measure voltage when oscillation waveform appears at pin 40. Impress pin 38 individually with separate power supply.		
C20	f _{sc} Free-Run Frequency	ON	0	0	0	1	0	0	0	0	0	Variable	0	0	0	(1) Input nothing to pin 42. (2) Change setting of SUB (10H) D4, D3 and D2 according to respective frequency modes, and measure frequency of CW signal of pin 35. Detail of D4, D3 and D2 3.58M = 1 : (001), 4.43M = 2 : (010) M-PAL = 6 : (110), N-PAL = 7 : (111)			
C21	f _{sc} Output Amplitude	OFF	0	0	0	0	0	0	0	0	0	0	0	0	0	0	(1) Input nothing to pin 42. (2) Change setting of SUB (10H) D4, D3 and D2 according to respective frequency modes. Measure the amplitude of output signal of pin 27.		

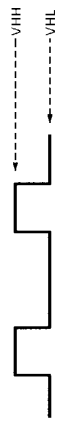
DEF SECTION		TEST CONDITION (Unless otherwise specified : H, RGB V _{CC} = 9V ; V _{DD} , Fsc V _{DD} , Y/C V _{CC} = 5V ; Ta = 25 ± 3°C ; BUS = preset value ;) (Note) "X" in the data column represents preset value at power ON.										
NOTE	ITEM	SUB-ADDRESS & BUS DATA										
DH1	H. Reference Frequency	Sub 02H	0	0	0	0	0	0	0	0	1	(1) Supply 5V to pin 26. (2) Set bus data as indicated on the left. (3) Measure the frequency of sync. output of pin 49.
DH2	H. Reference Oscillation Start Voltage	Sub 02H	0	0	0	0	0	0	0	0	1	In the test condition of the Note DH1, turning down the voltage supplied to pin 26 from 5V, measure the voltage when oscillation of pin 49 stops.
DH3	H. Output Frequency 1	Sub 10H	X	0	X	X	X	X	X	0	1	(1) Set bus data as indicated on the left. (2) In the condition of the above step 1, measure frequency (TH1) at pin 4.
DH4	H. Output Frequency 2	Sub 10H	X	0	X	X	X	X	X	1	0	(1) Set the input video signal of pin 51 to the 60 system. (2) Set bus data as indicated on the left. (3) In the above-mentioned condition, measure frequency (TH2) at pin 4.
DH5	H. Output Duty 1	—	—	—	—	—	—	—	—	—	—	(1) Supply 4.5V DC to pin 5 (or, make pin 5 open-circuited). (2) Measure duty of pin 4 output.
DH6	H. Output Duty 2	—	—	—	—	—	—	—	—	—	—	(1) Make a short circuit between pin 5 and ground. (2) Measure duty of pin 4 output.
DH7	H. Output Duty Switching Voltage	—	—	—	—	—	—	—	—	—	—	Supply 2V DC to pin 5. While turning down the voltage from 2V, measure voltage when the output duty ratio becomes 41 to 37%. Measure the low voltage and high voltage of pin 4 output whose waveform is shown below.
DH8	H. Output Voltage	—	—	—	—	—	—	—	—	—	—	
DH9	H. Output Oscillation Start Voltage	—	—	—	—	—	—	—	—	—	—	While raising H. V _{CC} (pin 3) from 0V, measure voltage when pin 4 starts oscillation.

NOTE	ITEM	SUB-ADDRESS & BUS DATA	TEST CONDITION (Unless otherwise specified : H, RGB VCC = 9 V ; Vpp, Fsc Vpp, Y/C VCC = 5 V ; Ta = 25 ± 3°C ; BUS = preset value ;) (Note) "X" in the data column represents preset value at power ON. MEASURING METHOD
			<p>(1) Supply 4.5 V DC to pin 5.</p> <p>(2) Input video signal to pin 48.</p> <p>(3) Set the width of pin 6 input pulse to 8 μs.</p> <p>(4) Measure φFBP shown in the figure below (φFBP).</p> <p>(5) Adjust the phase of pin 6 input pulse so that the center of pin 4's output pulse corresponds to the trailing edge of input sync. signal.</p> <p>(6) Set bus data as indicated on the left and measure the horizontal picture position with respective bus data settings (HSFTmax, HSFTmin).</p> <p>(7) Find HP difference between the conditions mentioned in the above step 6 (ΔHSFT).</p> <p>(8) Reset bus data to the preset value.</p> <p>(9) While impressing 5 V DC to pin 5, measure HP.</p> <p>(10) While impressing 4 V DC to pin 5, measure HP.</p> <p>(11) Find difference between the two measurement results obtained in the preceding steps 9 and 10 (ΔHCC).</p>
DH10	H. FBP Phase		
DH11	H. Picture Position, Maximum		
DH12	H. Picture Position, Minimum	0 0 0 0 0 0	
DH13	H. Picture position Control Range	1 1 1 1 1 1	
DH14	H. Distortion Correction Control Range		

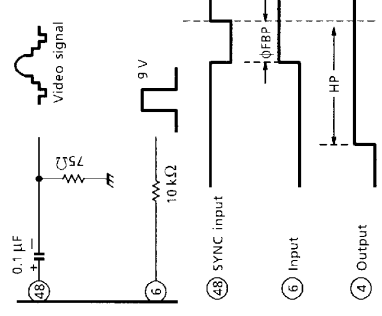

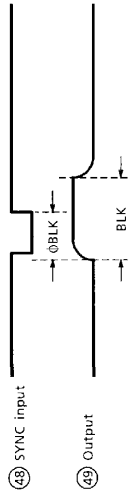
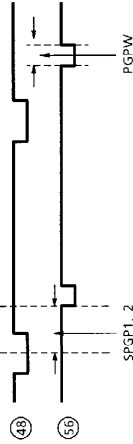
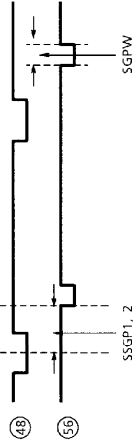
NOTE	ITEM	TEST CONDITION (Unless otherwise specified : H, RGB VCC = 9 V ; VDD, Fsc VDD, Y / C VCC = 5 V ; Ta = 25 ± 3°C ; BUS = preset value ;) (Note) "X" in the data column represents preset value at power ON.										
		MEASURING METHOD										
		SUB-ADDRESS & BUS DATA										
DH15	H. BLK Phase	Sub 02H	0	0	0	0	0	0	0	0	0	(1) In the condition of the steps 1 through 4 of the Note DH10, perform the following measurement. (2) Supply 5 V DC to pin 26. (3) Set bus data as indicated on the left. (4) Measure phase difference between pin 48 and pin 49 as shown below. (5) Change the bus data as shown on the left and measure BLK width.
DH16	H. BLK Width, Minimum	Sub 16H	0	0	×	×	×	×	×	×	×	
DH17	H. BLK Width, Maximum		1	1	×	×	×	×	×	×	×	
DH18	P / N-GP Start Phase 1	Sub 0FH	×	×	×	×	×	×	×	×	×	<p>(1) Supply 5 V to pin 26. (2) Set bus data as indicated on the left. (3) With the respective bus data settings mentioned above, measure the phase and gate width as shown in the figure below.</p> 
DH19	P / N-GP Start Phase 2		×	×	0	×	×	×	×	×	×	
DH20	P / N-GP Gate Width 1		×	×	×	×	1	×	×	×	×	
DH21	P / N-GP Gate Width 2		×	×	×	×	×	×	×	×	×	
DH22	SECAM-GP Start Phase 1	Sub 1FH	×	×	×	×	×	×	×	×	×	<p>(1) Supply 5 V to pin 26. (2) Set bus data as indicated on the left. (3) With the respective bus data settings mentioned above, measure the phase and gate width as shown in the figure below.</p> 
DH23	SECAM-GP Start Phase 2		×	×	0	×	×	×	×	×	×	
DH24	SECAM-GP Gate Width 1		×	×	×	×	1	×	×	×	×	
DH25	SECAM-GP Gate Width 2		×	×	×	×	×	×	×	×	×	

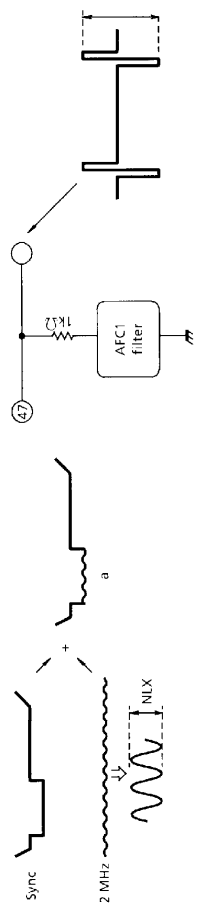

NOTE	ITEM	TEST CONDITION				SUB-ADDRESS & BUS DATA				MEASURING METHOD
		(Unless otherwise specified : H, RGB VCC = 9 V ; VDD, Fsc VDD, Y/C VCC = 5 V ; Ta = 25 ± 3°C ; BUS = preset value ;) pin48 input video signal = 50 system (Note) "X" in the data column represents preset value at power ON.								
DH26	Noise Detection Level 1	0	0	X	X	X	X	X	X	(1) Input such a signal as shown by "a" of the following figure to pin 48. (2) Set bus data as indicated in the first line of the left table. (3) Measure NLX when amplitude of pin 47 changes. → NL1 (4) Set bus data as indicated in the second line of the left table. (5) Measure NLX when amplitude of pin 47 changes. → NL2 (6) Set bus data as indicated in the third line of the left table. (7) Measure NLX when amplitude of pin 47 changes. → NL3 (8) Set bus data as indicated in the fourth line of the left table. (9) Measure NLX when amplitude of pin 47 changes. → NL4
DH27	Noise Detection Level 2	0	1	X	X	X	X	X	X	
DH28	Noise Detection Level 3	Sub 1DH	1	0	X	X	X	X	X	
DH29	Noise Detection Level 4		1	1	X	X	X	X	X	

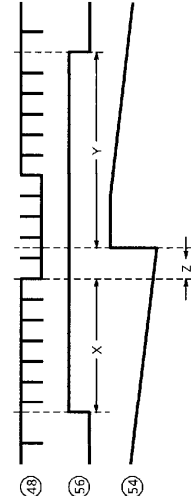
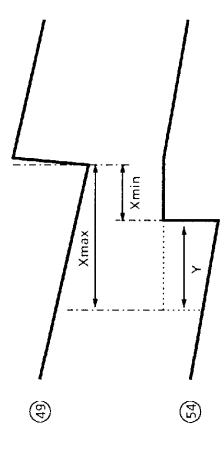

NOTE	ITEM	TEST CONDITION (Unless otherwise specified : H, RGB VCC = 9 V ; VDD, Fsc VDD, Y/C VCC = 5 V ; Ta = 25 ± 3°C ; BUS = preset value ;) pin 48 input video signal = 50 system (Note) " X " in the data column represents preset value at power ON.																
		MEASURING METHOD																
		SUB-ADDRESS & BUS DATA																
DV1	AFC-MASK Start Phase																	<p>(1) Supply 5 V DC to pin 26.</p> <p>(2) Set bus data as indicated on the left and activate the test mode.</p> <p>(3) Measure the AFC-MASK start phase (X) and AFC-MASK stop phase (Y) of pin 56.</p> <p>(4) Set the Sub 16H as indicated on the left.</p> <p>(5) Measure the VNFB start phase (Z) of pin 54.</p> 
DV2	AFC-MASK Stop Phase	Sub 02H	0	0	0	0	0	0	0	0	0	0	0	0	0	1		
DV3	VNFB Phase	Sub 16H	X	X	X	X	X	X	X	X	X	X	X	X	0	0		
DV4	V. Output Maximum Phase																	<p>(1) Input video signal to pin 48.</p> <p>(2) Measure both phases (Xmax, Xmin) of pin 49 and pin 54 with the respective bus data settings shown on the left.</p> <p>(3) Find difference between the two phases measured in the above step 2. Y = Xmax - Xmin</p> 
DV5	V. Output Minimum Phase	Sub 16H	X	X	X	X	X	X	X	X	X	X	X	X	1	1		
DV6	V. Output Phase Variable Range																	

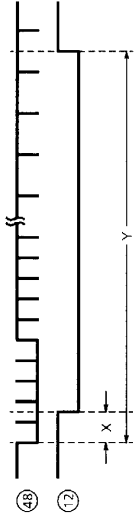
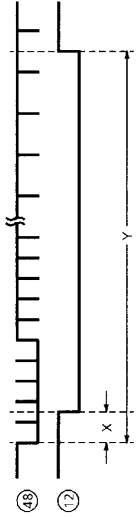
NOTE	ITEM	SUB-ADDRESS & BUS DATA							TEST CONDITION (Unless otherwise specified : H, RGB VCC = 9 V ; VDD, Fsc VDD, Y / C VCC = 5 V ; Ta = 25 ± 3°C ; BUS = preset value ;) (Note) "X" in the data column represents preset value at power ON.
		Sub 1CH	0	1	X	X	X	X	
DV7	50 System VBLK Start Phase	0	1	X	X	X	X	X	(1) Input such a video signal of the 50 system as shown in the figure to pin 48. (2) Set bus data as indicated on the left. (3) Measure the VBLK start phase (X) and VBLK stop phase (Y) of pin 12.
DV8	50 System VBLK Stop Phase	X	0	X	X	X	X	X	
DV9	60 System VBLK Start Phase	0	1	X	X	X	X	X	(1) Input such a video signal of the 60 system as shown in the figure to pin 48. (2) Set bus data as indicated on the left. (3) Measure the VBLK start phase (X) and VBLK stop phase (Y) of pin 12.
DV10	60 System VBLK Stop Phase	X	0	X	X	X	X	X	
DV11	V. Lead-In Range 1	Sub 16H	X	X	X	X	X	0	(1) Set bus data as indicated on the left. (2) Input 262.5 H video signal to pin 48. (3) Set a certain number of field lines in which signals of pin 48 and pin 54 completely synchronize with each other as shown in the figure below. (4) Decrease the field lines in number and measure number of lines in which pin 48 and pin 54 signals do not synchronize with each other. (5) Again set a certain number of field lines in which pin 48 and pin 54 signals synchronize with each other. (6) Increase the field lines in number and measure number of lines in which pin 48 and pin 54 signals do not synchronize with each other.
		Sub 19H	X	X	X	X	X	0	

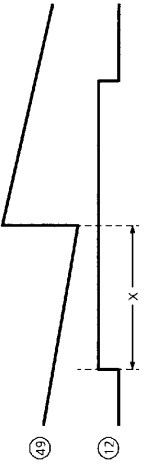

NOTE	ITEM	TEST CONDITION (Unless otherwise specified : H, RGB VCC = 9 V ; VDD, Fsc VDD, Y/C VCC = 5 V ; Ta = 25 ± 3°C ; BUS = preset value ;) (Note) "X" in the data column represents preset value at power ON.										
		SUB-ADDRESS & BUS DATA MEASURING METHOD										
DV12	V. Lead-In Range 2											<p>(1) Set bus data as indicated on the left.</p> <p>(2) Input 262.5 H video signal to pin 48.</p> <p>(3) Set a certain number of field lines in which signals of pin 48 and pin 54 completely synchronize with each other as shown in the figure below.</p> <p>(4) Decrease the field lines in number and measure number of lines in which pin 48 and pin 54 signals do not synchronize with each other.</p> <p>(5) Again set a certain number of field lines in which pin 48 and pin 54 signals synchronize with each other.</p> <p>(6) Increase the field lines in number and measure number of lines in which pin 48 and pin 54 signals do not synchronize with each other.</p>
		Sub 16H	X	X	X	X	X	X	0	0	0	
		Sub 19H	X	X	X	X	X	X	0	1	0	
DV13	VBLK Start Phase (Note) : Only the 60 system is subject to evaluation.											<p>(1) Set bus data as specified for the Sub 1DH in the left columns, and measure the value of X shown in the figure below.</p> <p>W-VBLK start phase : MAX, MIN</p>
		Sub 1DH	X	X	X	X	X	X	0	0	0	

NOTE	ITEM	TEST CONDITION (Unless otherwise specified : H, RGB V _{CC} = 9V ; V _{DD} , Fsc V _{DD} , Y/C V _{CC} = 5V ; Ta = 25 ± 3°C ; BUS = preset value ;) (Note) "X" in the data column represents preset value at power ON.																																								
		SUB-ADDRESS & BUS DATA																																								
		MEASURING METHOD																																								
DV14	VBLK Stop Phase																																									
	(Note) : Only the 60 system is subject to evaluation.	X	0	0	0	0	0	0	0	0	0	0	0	0	0	0	0	0	0	0	0	0	0	0	0	0	0	0	0	0	0	0	0	0	0	0	0	0	0	0	0	0

(1) Set bus data as specified for the Sub 1EH in the left columns, and measure the value of Y shown in the figure below.
W-VBLK stop phase : MAX, MIN

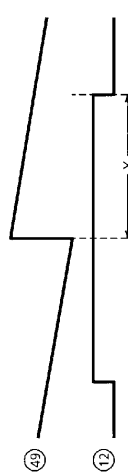

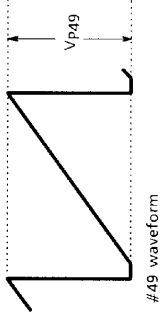
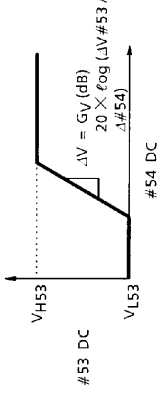
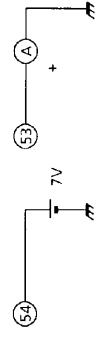
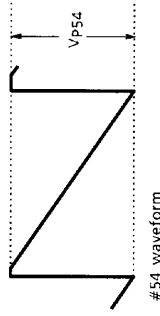

Deflection correction stage

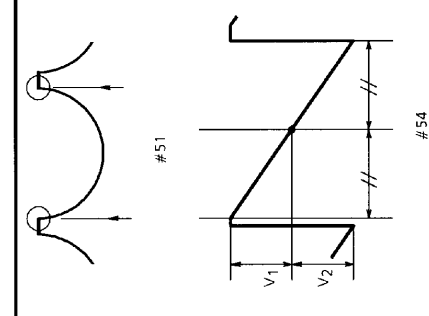
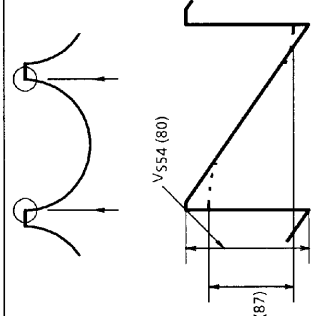
NOTE		TEST CONDITIONS (DEF V _{CC} = 9 V, T _a = 25 ± 3°C, BUS DATA = POWER-ON RESET)	
		SW MODE	MEASUREMENT METHOD
		SW28	
G1	Vertical Ramp Amplitude	A	<p>Measure the amplitude of the vertical ramp wave on #49.</p> 
G2	Vertical Amplification	A	<p>Set #53 and #54 to open. Set the subaddress (17) data to (80). Connect #54 to an external power supply. When the voltage is varied from 4.0 V to 6.0 V, measure the vertical amplification on the #53 voltage. (Gy) (VH53) (VL53)</p> 
G3	Vertical Amp Maximum Output Voltage	A	
G4	Vertical Amp Minimum Output Voltage	A	
G5	Vertical Amp Maximum Output Current	A	<p>Set #53 and #54 to open. Apply 7 V to #54 from an external source. Insert an ammeter between #53 and GND, and measure the current.</p> 
G6	Vertical NF Sawtooth Wave Amplitude	A	<p>Measure the amplitude of the #54 waveform (vertical sawtooth waveform).</p> 
G7	Vertical Amplitude Range	A	<p>When the subaddress (17) data are set to (MIN) and (MAX), measure the amplitudes of the #54 waveform (vertical sawtooth waveform) Vp54 (00) and Vp54 (FC).</p> $V_{PH} = \pm \frac{V_{P54(FC)} - V_{P54(00)}}{V_{P54(FC)} + V_{P54(00)}} \times 100 (\%)$

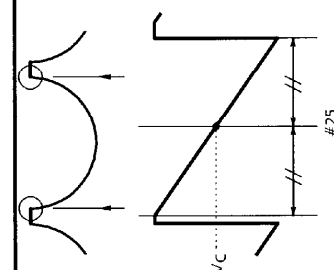
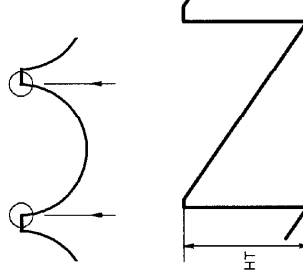
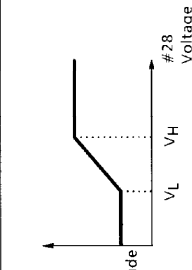
TEST CONDITIONS (DEF V _{CC} = 9 V, Ta = 25 ± 3°C, BUS DATA = POWER-ON RESET)		MEASUREMENT METHOD	
NOTE	ITEM	SW MODE SW28	
G8	Vertical Linearity Correction Maximum Value	A	<p>Set the subaddress (19) data to (F8). Change the subaddress (1B) D7~D4 so that the #51 parabola waveform is symmetrical. When the subaddress (1A) data are (80), measure the #54 waveform V1 (80) and V2 (80). Likewise, when the subaddress (0F) data are (00) and (F0), measure V1 (00), V2 (00), V1 (F0), and V2 (F0).</p> $V_l = \pm \frac{V_1(00) - V_1(F0) + V_2(F0) - V_2(00)}{2 \times (V_1(80) + V_2(80))}$ 
G9	Vertical S Correction Maximum Value	A	<p>Set the subaddress (19) data to (F8). Change the subaddress (1B) D7~D4 so that the #51 parabola waveform is symmetrical. When the subaddress (1A) data are (80), measure the amplitude of the #54 waveform V554 (80). Likewise, when the subaddress (19) data are (87), measure the amplitude of the #54 waveform V554 (87).</p> $V_s = \pm \frac{V_{554(80)} - V_{554(87)}}{V_{554(80)} + V_{554(87)}} \times 100 (\%)$ 

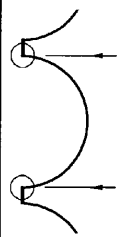
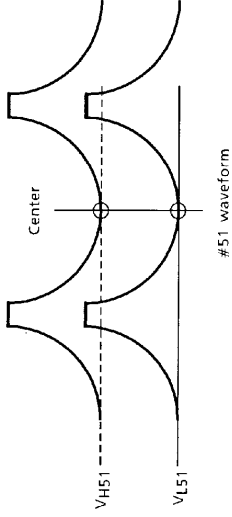
TEST CONDITIONS (DEF V _{CC} = 9 V, T _a = 25 ± 3°C, BUS DATA = POWER-ON RESET)		MEASUREMENT METHOD	
NOTE	ITEM	SW MODE	
		SW28	
G-10	Vertical NF Center Voltage	A	<p>Set the subaddress data (19) to (F8). Change the subaddress (1B) D7~D4 so that the #51 parabola waveform is symmetrical. Measure the center voltage V_C of the #54 waveform.</p> 
G-11	Vertical Amplitude EHT Correction	A	<p>Set the subaddress (19) data to (F8). Change the subaddress (1B) D7~D4 so that the #51 parabola waveform is symmetrical. Set the subaddress (1C) data to (40) and measure the amplitude of the #54 waveform VEHT (40). Set the subaddress (1C) data to (47) and measure the amplitude of the #54 waveform VEHT (47).</p> $VEHT = \frac{VEHT(40) - VEHT(47)}{VEHT(40)} \times 100 (\%)$ 
G-12	EHT Dynamic Range	A	<p>Set the subaddress data (19) to (F8). Change the subaddress (1B) D7~D4 so that the #51 parabola waveform is symmetrical. Set the subaddress (1C) data to (47). Change #28 input voltage at 1~7 V and measure the amplitude of the #54 waveform.</p> 

TEST CONDITIONS (DEF $V_{CC} = 9V$, $T_a = 25 \pm 3^\circ C$, BUS DATA = POWER-ON RESET)		MEASUREMENT METHOD	
NOTE	ITEM	SW MODE	
G13	E-W NF Maximum DC Value (Picture Width)	B	 <p>Set the subaddress (19) data to (F8). Change the subaddress (1B) D7~D4 so that the #22 parabola waveform is symmetrical. Set the subaddress (19) data to (80). Set the subaddress (18) data to (00) and measure the #51 voltage VL51. Set the subaddress (18) data to (FE) and measure the #51 voltage VH51.</p>
	E-W NF Minimum DC Value (Picture Width)		 <p>#51 waveform</p>
G15	E-W NF Parabola Maximum Value (Parabola)	B	<p>Set the subaddress (18) data to (00) and the subaddress (19) data to (F8). Measure the amplitude of the #51 waveform (parabola waveform) VPB.</p>  <p>#51 waveform</p>

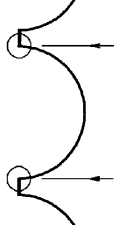
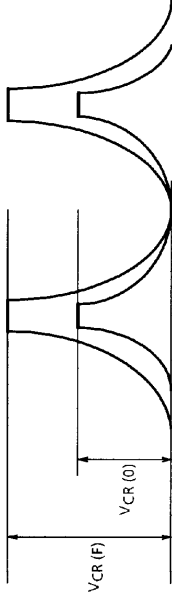
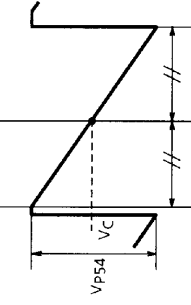
TEST CONDITIONS (DEF V _{CC} = 9 V, Ta = 25 ± 3°C, BUS DATA = POWER-ON RESET)		MEASUREMENT METHOD	
NOTE	ITEM	SW MODE SW28	
G16	E-W NF Corner Correction (Corner)	B	<p>Set the subaddress (19) data to (F8). Change the subaddress (1B) D7~D4 so that the #51 parabola waveform is symmetrical.</p>  <p>Set the subaddress (1B) D3~D0 to (0) and measure the amplitude of the #51 waveform V_{CR(0)}. Likewise, when the subaddress (1B) data are set to (F), measure the #51 waveform amplitude V_{CR(F)}.</p> $VCR = VCR(0) - VCR(F)$ 
G17	Parabola Symmetry Correction	A	<p>Set the subaddress (1B) data to (08) and measure the vertical NF center voltage of the #54 waveform V_{C(00)}. Likewise, when the subaddress (1B) data are set to (F8), measure the #54 waveform V_{C(FC)}.</p> $VTR = \pm \frac{V_C(00) - V_C(FC)}{2 \times VP54} \times 100 (\%)$ 
G18	E-W Parabola EHT Value	--	<p>Set the subaddress (19) data to (F8). Change the subaddress (1B) D7~D4 so that the #51 parabola waveform is symmetrical. Set the subaddress data (1C) to (40). While supplying 1.0 V to pin 28, measure amplitude V_{EH(1)} at pin 51. While supplying 7.0 V to pin 28, measure amplitude V_{EH(7)} at pin 51.</p> $VEH1 = \frac{VEH(7) - VEH(1)}{VEH(7)} \times 100 (\%)$

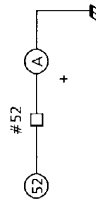
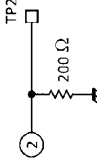
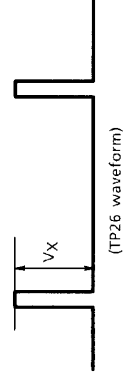
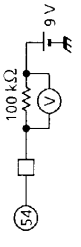
NOTE	ITEM	TEST CONDITIONS (DEF V _{CC} = 9 V, T _a = 25 ± 3°C, BUS DATA = POWER-ON RESET)	
		SW MODE SW28	MEASUREMENT METHOD
G19	E-W DC EHT Value	A	<p>Set the subaddress (19) data to (F8). Change the subaddress (1B) D7~D4 so that the #51 parabola waveform is symmetrical.</p> <p>Set the subaddress (1C) data to (40) and measure amplitude V_{EH} (40) at pin 51.</p> <p>Set the subaddress (1C) data to (78) and measure amplitude V_{EH} (78) at pin 51.</p> <p>VEH2 = VEH (78) — VEH (40) (V)</p>
G20	E-W Amp Maximum Output Current	A	<p>Connect an ammeter between #52 and GND.</p> <p>Measure the current.</p> 
G21	AGC Operating Current 1	A	<p>Measure the #2 waveform peak value. (VAGC0)</p> <p>Set the subaddress (0F) D0 to (1) and repeat the measurement. (VAGC1)</p> 
G22	AGC Operating Current 2	A	<p>$I_{AGC0} = V_X \div 200 (\mu A)$ (I_{AGC1})</p> 
G23	Vertical Guard Voltage	A	<p>Set #54 to open. Connect an external power supply to #54. Decrease the voltage from 5 V. When full blanking is applied to #14, measure the voltage.</p>
G24	V NFB Pin Input Current	A	<p>Connect a 9-V V_{CC} via a 100-kΩ resistor to #54. Measure the sink current on #54 according to the voltage difference of the 100-kΩ resistance.</p> <p>$I_{54} = V / 100 \text{ k}\Omega$</p> 

1H DL SECTION

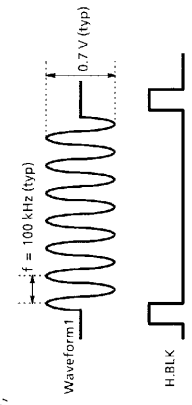
NOTE		ITEM	TEST CONDITION (Unless otherwise specified : H, RGB VCC = 9 V ; VDD, Fsc VDD, Y/C VCC = 5 V ; Ta = 25 ± 3°C ; BUS = preset value ; pin3 = 9 V ; pin8 -38-41 = 5 V)			MEASURING METHOD	
			SW MODE	SUB ADDRESS & DATA			
			S26	07H	0FH	11H	
H1	1HDL Dynamic Range Direct	ON	94H	—	—	—	<p>(1) Input waveform 1 to pin 33 (B-Yin), and measure VNBD, that pin 36 (B-Yout) is saturated input level.</p> <p>(2) Measure VNRD of R-Y input in the same way as VNBD.</p> 
H2	1HDL Dynamic Range Delay	↑	8CH	—	—	—	<p>(1) Input waveform 1 to pin 33 (B-Yin), and measure VPBD, that pin 36 (B-Yout) is saturated input level.</p> <p>(2) Measure VPRD of R-Y input in the same way as VPBD.</p>
H3	1HDL Dynamic Range, Direct + Delay	↑	A4H	—	—	—	<p>(1) Input waveform 1 to pin 33 (B-Yin), and measure VSBD, that pin 36 (B-Yout) is saturated input level.</p> <p>(2) Measure VNRD of R-Y input in the same way as VSBD.</p>
H4	Frequency Characteristic, Direct	↑	94H	—	—	—	<p>(1) In the same measuring as H1, set waveform 1 to 0.3 V_{p-p} and f = 100 kHz. Measure VB100, that is pin 36 (B-Yout) level. And set waveform 1 to f = 700 kHz. Measure VB700, that is pin 36 (B-Yout) level.</p> <p>(2) Measure GHR1 of R-Y out in the same way as GHB1.</p>
H5	Frequency Characteristic, Delay	↑	8CH	—	—	—	<p>(1) In the same measuring as H1, set waveform 1 to 0.3 V_{p-p} and f = 100 kHz. Measure VB100, that is pin 36 (B-Yout) level. And set waveform 1 to f = 700 kHz. Measure VB700, that is pin 36 (B-Yout) level.</p> <p>(2) Measure GHR2 of R-Y out in the same way as GHB2.</p>
H6	AC Gain Direct	↑	94H	—	—	—	<p>(1) In the same measuring as H1, set waveform 1 to 0.7 V_{p-p}. Measure VByt1, that is pin 36 (B-Yout) level.</p> <p>(2) Measure GRY1 of R-Y out in the same way as GBY1.</p>
H7	AC Gain Delay	↑	8CH	—	—	—	<p>(1) In the same measuring as H1, set waveform 1 to 0.7 V_{p-p}. Measure VByt2, that is pin 36 (B-Yout) level.</p> <p>(2) Measure GRY2 of R-Y out in the same way as GBY2.</p>

NOTE	ITEM	TEST CONDITION (Unless otherwise specified :H, RGB VCC = 9 V ; VDD, Fsc VDD, Y/C VCC = 5 V ; Ta = 25 ± 3°C ; BUS = preset value ; pin3 = 9 V ; pin8-38-41 = 5 V)			MEASURING METHOD
		SW MODE	SUB ADDRESS & DATA		
		S26	07H	0FH	11H
H8	Direct-Delay AC Gain Difference	↑	94H 8CH	—	—
H9	Color Difference Output DC Stepping	↑	8CH	—	—
H10	1H Delay Quantity	ON	8CH	—	—
H11	Color Difference Output DC-Offset Control	↑	8CH	20H	00H 88H FFH
H12	Color Difference Output DC-Offset Control / Min. Control Quantity	↑	A4H	00H	89H
H13	NTSC Mode Gain / NTSC-COM Gain	↑	94H	80H	—

(1) Input waveform 2 to pin 33 (B-Yin). And measure the time deference Bdt of pin 36 (B-Yout).
 (2) Input waveform 2 to pin 34 (R-Yin). And measure the time difference Rdt of pin 36 (B-Yout).

The diagram shows a sequence of signals: Waveform 2 (a square wave), Output waveform (a square wave with a delay), Bdt (a narrow pulse), and H-BLK (a square wave). Arrows indicate the time difference Bdt between the start of Waveform 2 and the start of the Output waveform.

(1) Set Sub-Address 11h ; data 88h. Measure the pin 36 DC voltage, that is BDC1.
 (2) Set Sub-Address 11h ; data 88h. Measure the pin 35 DC voltage, that is RDC1.
 (3) Set Sub-Address 11h ; data 00h. Measure the pin 36 DC voltage, that is BDC2.
 (4) Set Sub-Address 11h ; data 00h. Measure the pin 35 DC voltage, that is RDC2.
 (5) Set Sub-Address 11h ; data FFh. Measure the pin 36 DC voltage, that is BDC3.
 (6) Set Sub-Address 11h ; data FFh. Measure the pin 35 DC voltage, that is RDC3.
 (7) Bomin = BDC2 — BDC1, Bomax = BDC3 — BDC1, Romin = RDC2 — RDC1, Romax = RDC3 — RDC1

(1) Measure the pin 36 DC voltage, that is BDC4.
 (2) Measure the pin 35 DC voltage, that is RDC4.
 (3) Bo1 = BDC4 — BDC1, Ro1 = RDC4 — RDC1

(1) Input waveform 1, that is set 0.3 V_{p-p} and f = 100 kHz, to pin 33. Measure pin 36 output level, that is VBNC.
 (2) GNB = 20 log (VBNC / VB100)
 (3) In the same way as (1) and (2), measure the pin 36 output level, that is VRNC.
 GNR = 20 log (VRNC / VR100)

TEXT SECTION

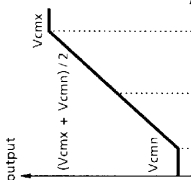
NOTE	ITEM	TEST CONDITION (Unless otherwise specified : H, RGB VCC = 9V ; VDD, Fsc VDD, Y/C VCC = 5V ; Ta = 25 ± 3°C ; BUS = preset value)												
		SW MODE			SUB-ADDRESS & BUS DATA							MEASURING METHOD		
		S21	S22	S31	S33	S34	S51		00H	02H				
T1	Y Color Difference Clamping Voltage	B	B	B	B	A	—	—	FFH	00H	—	—	—	(1) Short circuit pin 31 (Y IN), pin 34 (R-Y IN) and pin 33 (B-Y IN) in AC coupling. (2) Input 0.3 V synchronizing signal to pin 48 (Sync IN). (3) Measure voltage at pin 31, pin 34 and pin 33 (Vcp31, Vcp34, Vcp33).
T2	Contrast Control Characteristic	↑	↑	↑	↑	↑	—	—	FFH	80H	00H	—	—	(1) Input TG7 sine wave signal whose frequency is 100 kHz and video amplitude is 0.7 V to pin 31 (Y IN). (2) Input 0.3 V Synchronizing Signal to pin 48 (Sync IN). (3) Connect both pin 21 (Digital Ys) and pin 22 (Analog Ys) to ground. (4) Set bus data so that Y sub contrast and drive are set at each center value and color is minimum. (5) Varying data on contrast from maximum (FF) to minimum (00), measure maximum and minimum amplitudes of respective outputs of pin 14 (R OUT), pin 13 (G OUT) and pin 12 (B OUT) in video period, and read values of bus data at the same time. Also, measure the respective amplitudes with the bus data set to the center value (80). (Vc12mx, Vc12mn, D12c80) (Vc13mx, Vc13mn, D13c80) (Vc14mx, Vc14mn, D14c80) (6) Find ratio between amplitude with maximum unicolor and that with minimum unicolor in conversion into decibel ($\Delta V13ct$). 
T3	AC Gain	↑	↑	↑	↑	↑	—	—	—	—	—	—	—	In the test condition of Note T2, find output/input gain (double) with maximum contrast. G = Vc13mx/0.7V

NOTE	ITEM	TEST CONDITION (Unless otherwise specified : H, RGB V _{CC} = 9 V ; V _{DD} , Fsc V _{DD} , Y/C V _{CC} = 5 V ; Ta = 25 ± 3°C ; BUS = preset value)													
		SW MODE					SUB-ADDRESS & BUS DATA					MEASURING METHOD			
		S21	S22	S31	S33	S34	S51			00H	02H				
T4	Frequency Characteristic	B	B	B	B	B	A				FFH	00H			(1) Input TG7 sine wave signal whose frequency is 6 MHz and video amplitude is 0.7 V to pin 31 (Y IN). (2) Input 0.3 V synchronizing signal to pin 48 (Sync IN). (3) Connect both pin 21 (Digital Ys) and pin 22 (Analog Ys) to ground. (4) Set bus data so that contrast is maximum, Y sub contrast and drive are set at each center value and color is minimum. (5) Measure amplitude of pin 13 signal (G OUT) and find the output/input gain (double) (G6M). (6) From the results of the above step 5 and the Note T3, find the frequency characteristic. Gf = 20 fog (G6M / G)

NOTE	ITEM	TEST CONDITION (Unless otherwise specified : H, RGB VCC = 9V ; VDD, Fsc VDD, Y/C VCC = 5V ; Ta = 25 ± 3°C ; BUS = preset value)															
		SW MODE			SUB-ADDRESS & BUS DATA							MEASURING METHOD					
		S21	S22	S31	S33	S34	S35	S41	S42								
T5	Y Sub-Contrast Control Characteristic	B	B	B	B	B	A	—	—	—	—	—	—	—	—	—	<p>(1) Connect both pin 21 (Digital Ys) and pin 22 (Analog Ys) to ground.</p> <p>(2) Input TG7 sine wave signal whose frequency is 100 kHz and video amplitude is 0.7 V to pin 31 (Y IN).</p> <p>(3) Input 0.3 V synchronizing signal to pin 48 (Sync IN).</p> <p>(4) Set bus data so that contrast is maximum, drive is set at center value and color is minimum.</p> <p>(5) Set bus data on Y sub contrast at maximum (FF) and measure amplitude (Vscmx) of pin 14 output (R OUT). Then, set data on Y sub contrast at minimum (00), measure the same (Vscmn).</p> <p>(6) From the results of the above step 5, find ratio between Vscmx and Vscmn in conversion into decibel (ΔVscnt).</p>
T6	Y2 Input Level	↑	↑	↑	↑	↑	↑	—	—	—	—	—	—	—	—	—	<p>(1) Set bus data so that contrast is maximum, Y sub contrast and drive are at each center value.</p> <p>(2) Input 0.3 V synchronizing signal to pin 48 while inputting TG7 sine wave signal whose frequency is 100 kHz to pin 31 (TY IN).</p> <p>(3) While increasing the amplitude of the sine wave signal, measure video amplitude of signal 1 just before R output of pin 14 is distorted. (Vy2d)</p>

NOTE	ITEM	TEST CONDITION (Unless otherwise specified : H, RGB VCC = 9V ; VDD, Fsc VDD, Y/C VCC = 5V ; Ta = 25 ± 3°C ; BUS = preset value)												
		SW MODE			SUB-ADDRESS & BUS DATA							MEASURING METHOD		
		S21	S22	S31	S33	S34	S51	S42	00H	02H	05H		1CH	08H
T7	Unicolor Control Characteristic	B	B	B	B	B	A	—	—	—	—	80H	—	3FH
									FFH					
									80H					
									00H					
T8	Relative Amplitude (NTSC)	↑	↑	A	A	A	↑	A	—	—	—	—	—	↑
T9	Relative Phase (NTSC)	↑	↑	↑	↑	↑	↑	↑	↑	—	—	—	—	↑

(1) Input 0.3 V synchronizing signal to pin 48 (Sync IN).
 (2) Input 100 kHz, 0.3 V_{p-p} sine wave signal to both pin 33 (B-Y IN) and pin 34 (R-Y IN).
 (3) Connect pin 21 (Digital Ys) and pin 22 (Analog Ys) to ground.
 (4) Set bus data so that drive is at center value, Y mute is on and color limiter is OFF.
 (5) While changing bus data on unicolor from maximum (FF) to minimum (00), measure maximum and minimum amplitudes of pin 12 (B OUT) in video period respectively, and read the bus data together with.
 Also, measure respective amplitudes as unicolor data is set at center value (80).
 (Vn12mx, Vn12mn, D12n80)
 (Vn14mx, Vn14mn, D14n80)
 (6) Find ratio between amplitude with maximum unicolor data and that with minimum unicolor data in conversion into decibel ($\Delta V/14\text{un}$).
 While inputting rainbow color bar signal (3.58 MHz for NTSC) to pin 42 and 0.3 V synchronizing signal to pin 48 so that video amplitude of pin 33 is 0.38 V_{p-p}, find the relative amplitude.
 (Mnr-b = Vu14mx/Vu12mx, Mng-b = Vu13mx/Vu12mx)
 (1) In the test condition of the Note T8, adjust bus data on tint so that output of pin 12 (B OUT) has the peak level in the 6th bar.
 (2) Regarding the phase of pin 12 (B OUT) as a reference phase, find comparative phase differences of pin 14 (R OUT) and pin 13 (G OUT) from the reference phase respectively (θ_{nr-b} , θ_{ng-b}).

NOTE	ITEM	TEST CONDITION (Unless otherwise specified : H, RGB V _{CC} = 9V ; V _{DD} , Fsc V _{DD} , Y/C V _{CC} = 5V ; Ta = 25 ± 3°C ; BUS = preset value)												
		SW. MODE			SUB-ADDRESS & BUS DATA							MEASURING METHOD		
		S21	S22	S31	S33	S34	S51	S42	—	00H 02H 1CH 1DH	—			
T10	Relative Amplitude (PAL)	B	B	A	A	A	A	A	—	FFH	—	80H 3FH	—	While inputting rainbow color bar signal (4.43 MHz for PAL) to pin 42 and 0.3V synchronizing signal to pin 48 so that video amplitude of pin 33 is 0.38 V _{p-p} , find the relative amplitude. (Mpr-b = Vu14mx/Vu12mx, Mpg-b = Vu13mx/Vu12mx)
T11	Relative Phase (PAL)	↑	↑	↑	↑	↑	↑	↑	—	↑	—	—	—	(1) In the test condition of the Note T10, adjust bus data on tint so that output of pin 12 (B OUT) has the peak level in the 6th bar. (2) Regarding the phase of pin 12 (B OUT) as a reference phase, find comparative phase differences of pin 14 (R OUT) and pin 13 (G OUT) from the reference phase respectively (θpr-b, θpg-b).
T12	Color Control Characteristic	↑	↑	B	B	B	↑	—	—	↑	FFH	↑	—	(1) Input 0.3V synchronizing signal to pin 48 (Sync IN). (2) Input 100 kHz, 0.1 V _{p-p} sine wave signal to both pin 33 (B-Y IN) and pin 34 (R-Y IN). (3) Connect pin 21 (Digital Ys) and pin 22 (Analog Ys) to ground. (4) Set bus data so that unicolor is maximum, drive is at center value and Y mute is on. (5) Measure amplitude of pin 12 (B OUT) as bus data on color is set maximum (FF). (V _{cmx}) (6) Read bus data when output level of pin 12 is 10%, 50% and 90% of V _{cmx} respectively (Dc10, Dc50, Dc90). (7) From results of the above step 6, calculate number of steps from Dc10 to Dc90 (Δcol) and that from 00 to Dc50 (ecol). (8) Measure respective amplitudes of pin 12 (B OUT), pin 13 (G OUT) and pin 14 (R OUT) with color data set at minimum, and regard the results as color residuals (ecb, ecb, ecr).
T13	Color Control Characteristic, Residual Color	↑	↑	↑	↑	↑	↑	—	—	↑	00H	↑	—	

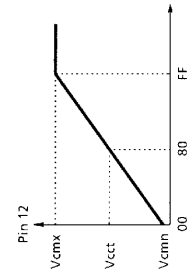

NOTE	ITEM	TEST CONDITION (Unless otherwise specified : H, RGB V _{CC} = 9 V ; V _{DD} , Fsc V _{DD} , Y/C V _{CC} = 5 V ; Ta = 25 ± 3°C ; BUS = preset value)														
		SW MODE			SUB-ADDRESS & BUS DATA							MEASURING METHOD				
		S21	S22	S31	S33	S34	S51	S42	S42	1CH	1DH					
T14	Chroma Input Range	B	B	A	A	A	A	A	—	FFH	88H	80H	3FH	—	—	(1) Input rainbow color bar signal (3.58 MHz for NTSC or 4.43 MHz for PAL) to pin 42 (C IN) and 0.3 V synchronizing signal to pin 48 (Sync IN). (2) Connect pin 36 (B-Y OUT) and pin 33 (B-Y IN), pin 35 (R-Y OUT) and pin 34 (R-Y IN) in AC coupling respectively. (3) Connect pin 21 (Digital Ys) and pin 22 (Analog Ys) to ground. (4) Set bus data so that unicolor is maximum, drive and color are set at each center value (80) and mute is on. (5) While increasing amplitude of chroma signal input to pin 42, measure amplitude just before any of pin 12 (B OUT), pin 13 (G OUT) and pin 14 (R OUT) output signals is distorted (Vcr).

NOTE	ITEM	TEST CONDITION (Unless otherwise specified : H, RGB V _{CC} = 9V ; V _{DD} , Fsc V _{DD} , Y/C V _{CC} = 5V ; Ta = 25 ± 3°C ; BUS = preset value)												
		SW MODE		SUB-ADDRESS & BUS DATA								MEASURING METHOD		
		S21	S22	S31	S33	S34	S51							
T15	Brightness Control Characteristic	B	B	B	B	B	A	—	—	01H 05H	—	—	—	(1) Short circuit pin 31 (Y IN), pin 33 (B-Y IN) and pin 34 (R-Y IN) in AC coupling. (2) Input 0.3 V synchronizing signal to pin 48 (Sync IN). (3) Set bus data so that R, G, B cut off data are set at center value. (4) Connect pin 21 (Digital Ys) and pin 22 (Analog Ys) to ground. (5) While changing bus data on brightness from maximum to minimum, measure video voltage of pin 13 (G OUT) to find maximum and minimum voltages (max : Vbrmx, min : Vbrmn). (6) With bus data on brightness set at center value, measure video voltage of pin 13 (G OUT) (Vbct). (7) On the condition that bus data with which Vbrmx is obtained in measurement of the above step 5 is Dbrmx and bus data with which Vbrmn is obtained in measurement of the above step 5 is Dbrmn, calculate sensitivity of brightness data ($\Delta Vbrt$). $\Delta Vbrt = (Vbrmx - Vbrmn) / (Dbrmx - Dbrmn)$
T16	Brightness Center Voltage	↑	↑	↑	↑	↑	↑	—	—	80H	↑	—	—	(1) In the same manner as the Note T16, measure video voltage of pin 12 (B OUT) with bus data on brightness set at center value. (2) Find maximum axes difference in the brightness center voltage.
T17	Brightness Data Sensitivity	↑	↑	↑	↑	↑	↑	—	—	—	—	—	—	(1) Set bus data so that contrast and Y sub contrast are maximum and brightness is minimum. (2) Input TG7 sine wave signal whose frequency is 100 kHz and amplitude in video period is 0.9 V to pin 31 (Y IN). (3) Connect pin 21 (Digital Ys) and pin 22 (Analog Ys) to ground. (4) While turning on/off WPL with bus, measure video amplitude of pin 14 (R OUT) with WPL being activated (Vwpl).
T18	RGB Output Voltage Axes Difference	↑	↑	↑	↑	↑	↑	—	—	—	—	—	—	
T19	White Peak Limit Level	↑	↑	↑	↑	↑	↑	—	—	00H 1FH	—	—	—	

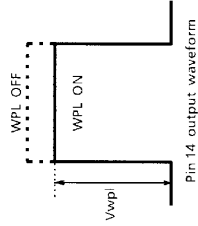

TB1245N-79

NOTE	ITEM	TEST CONDITION (Unless otherwise specified : H, RGB V _{CC} = 9V ; V _{DD} , Fsc V _{DD} , Y/C V _{CC} = 5V ; Ta = 25 ± 3°C ; BUS = preset value)													
		SW MODE			SUB-ADDRESS & BUS DATA							MEASURING METHOD			
		S21	S22	S31	S33	S34	S51								
T20	Cutoff Control Characteristic	B	B	B	B	A	—	—	—	—	80H 80H	FFH FFH 00H 00H	FFH FFH 00H 00H	—	(1) Short circuit pin 31 (Y IN), pin 33 (B-Y IN) and pin 34 (R-Y IN) in AC coupling. (2) Input 0.3V synchronizing signal to pin 48 (Sync IN). (3) Connect pin 21 (Digital Ys) and pin 22 (Analog Ys) to ground. (4) Set bus data on brightness at center value. (5) While changing data on cutoff from maximum to minimum, measure video voltage of pin 13 (G OUT) to find maximum and minimum values (max : V _{comx} , min : V _{comn}). (6) Set cutoff data at center value and measure video voltage of pin 13 (G OUT) (V _{coct}). (7) On the condition that bus data with which V _{comx} is obtained in measurement of the above step 5 is D _{comx} and bus data with which V _{comn} is obtained in the same is D _{comn} , calculate number of steps (ΔDcut). ΔDcut = D _{comx} - D _{comn}
T21	Cutoff Center Level	↑	↑	↑	↑	↑	—	—	—	—	↑	80H 80H	80H 80H	—	
T22	Cutoff Variable Range	↑	↑	↑	↑	↑	—	—	—	—	—	—	—	—	
T23	Drive Variable Range	↑	↑	↑	↑	↑	—	—	—	—	FFH FFH 00H 00H	80H 80H	80H 80H	—	(1) Short circuit pin 33 (B-Y IN) and pin 34 (R-Y IN) in AC coupling. (2) Input a stepping signal whose amplitude in video period is 0.3V to pin 31 (Y IN). (3) Input 0.3V synchronizing signal to pin 48 (Sync IN). (4) Connect pin 21 (Digital Ys) and pin 22 (Analog Ys) to ground. (5) Set bus data so that contrast is maximum and Y sub contrast is minimum. (6) While changing drive data from minimum to maximum, measure video amplitude of pin 13 (G OUT) to find maximum and minimum values (max : V _{drmx} , min : V _{drmn}). (7) Set drive data at center value and measure video amplitude of pin 13 (G OUT) (V _{drct}). Calculate amplitude ratio of the measured value to the maximum and minimum amplitudes measured in the above step 6 respectively (DR+, DR-).

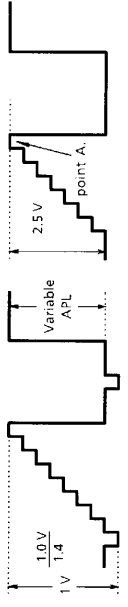
NOTE	ITEM	TEST CONDITION (Unless otherwise specified : H, RGB V _{CC} = 9 V ; V _{DD} , Fsc V _{DD} , Y/C V _{CC} = 5 V ; Ta = 25 ± 3°C ; BUS = preset value)														
		SW MODE			SUB-ADDRESS & BUS DATA									MEASURING METHOD		
		S21	S22	S31	S33	S34	S51	S45	S39	S44						
T24	DC Regeneration	B	B	A	B	A	A	B	A	A						<p>(1) Short circuit pin 33 (B-Y IN) and pin 34 (R-Y IN) in AC coupling.</p> <p>(2) Input such the step-up signal as shown below to pin 45 (Y IN) and pin 48 (Sync IN).</p> <p>(3) Connect pin 21 (Digital Ys) and pin 22 (Analog Ys) to ground.</p> <p>(4) Set bus data so that contrast is maximum and DC transmission correction factor is minimum.</p> <p>(5) Adjust data on Y sub contrast so that video amplitude of pin 13 (G OUT) is 2.5 V.</p> <p>(6) While varying APL of the step-up signal from 10% to 90%, measure change in voltage at the point A.</p> 
T25	RGB Output S/N Ratio	↑	↑	B	↑	↑	↑	—	—	—	—	—	—	—	—	<p>(1) Short circuit pin 31 (Y IN), pin 33 (B-Y IN) and pin 34 (R-Y IN) in AC coupling.</p> <p>(2) Input synchronizing signal of 0.3 V in amplitude to pin 48 (Sync IN).</p> <p>(3) Connect pin 21 (Digital Ys) and pin 22 (Analog Ys) to ground.</p> <p>(4) Set bus data on contrast at maximum.</p> <p>(5) Set bus data on Y sub contrast at center value.</p> <p>(6) Measure video noise level of pin 13 (G OUT) with oscilloscope (no).</p> <p>SNo = -20 fog (2.5 / (1/5) X no)</p>

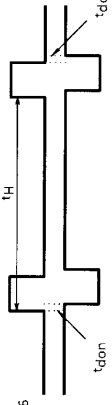
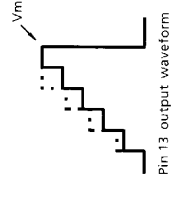
NOTE	ITEM	TEST CONDITION (Unless otherwise specified : H, RGB V _{CC} = 9 V ; V _{DD} , Fsc V _{DD} , Y/C V _{CC} = 5 V ; Ta = 25 ± 3°C ; BUS = preset value)														
		SW MODE					SUB-ADDRESS & BUS DATA									
		S21	S22	S31	S33	S34	S51	—	—	—	07H	05H	08H	0CH	0DH	0EH
T26	Blanking Pulse Output Level	B	B	B	B	B	A	—	—	—	—	—	—	—	—	<p>(1) Input synchronizing signal of 0.3 V in amplitude to pin 48 (Sync IN).</p> <p>(2) Connect pin 21 (Digital Ys) and pin 22 (Analog Ys) to ground.</p> <p>(3) Set bus data so that blanking is on.</p> <p>(4) Measure voltage of pin 13 (G OUT) in V. blanking period (Vy).</p> <p>(5) Measure voltage of pin 13 (G OUT) in H. blanking period (Vh).</p> <p>In the setting condition of the Note T26, find "tdon" and "tdoff" (see figure below) between the signal impressed to pin 6 (BFP IN) and output signal of pin 13 (G OUT).</p>
T27	Blanking Pulse Delay Time	↑	↑	↑	↑	↑	↑	↑	↑	↑	↑	↑	↑	↑	↑	 <p>(1) Short circuit pin 31 (Y IN), pin 33 (B-Y IN) and pin 34 (R-Y IN) in AC coupling.</p> <p>(2) Input synchronizing signal of 0.3 V in amplitude to pin 48 (Sync IN).</p> <p>(3) Connect pin 21 (Digital Ys) and pin 22 (Analog Ys) to ground.</p> <p>(4) Set bus data so that brightness and RGB cutoff are minimum.</p> <p>(5) Measure video voltage of pin 13 (G OUT) (Vmn).</p>
T28	RGB Min. Output Level	↑	↑	↑	↑	↑	—	—	—	—	—	—	—	—	—	<p>(1) Short circuit pin 33 (B-Y IN) and pin 34 (R-Y IN) in AC coupling.</p> <p>(2) Input stepping signal to pin 31 (Y IN) and synchronizing signal of 0.3 V in amplitude to pin 48 (Sync IN).</p> <p>(3) Connect pin 21 (Digital Ys) and pin 22 (Analog Ys) to ground.</p> <p>(4) Set bus data so that contrast and</p>
T29	RGB Max. Output Level	↑	↑	↑	↑	↑	—	—	—	—	—	—	—	—	—	<p>(3) Connect pin 21 (Digital Ys) and pin 22 (Analog Ys) to ground.</p> <p>(4) Set bus data so that contrast and Y sub contrast are maximum.</p> <p>(5) While increasing amplitude of the stepping signal, measure maximum output level just before video signal of pin 13 (G OUT) is distorted (Vmx).</p> 

NOTE	ITEM	TEST CONDITION (Unless otherwise specified : H, RGB VCC = 9V ; VDD, Fsc VDD, Y/C VCC = 5V ; Ta = 25 ± 3°C ; BUS = preset value)													
		SW_MODE								SUB-ADDRESS & BUS DATA			MEASURING METHOD		
		S18	S19	S20	S21	S22	S31	S33	S34	S51	15H	04H			
T30	Half-tone Ys Level	B	B	B	A	B	B	B	A	00H	40H	—	—	—	(1) Input stepping signal whose amplitude is 0.3 V in video period to pin 31 (Y IN) and pin 48 (Sync IN). (2) Set bus data so that blanking is off and half-tone is -3 dB in on status. (3) Connect power supply to pin 21 (Digital Ys). While impressing 0 V to it, measure amplitude and pedestal level of pin 13 (G OUT) in video period (Vm13, Vp13). (4) Raising supply voltage to pin 21 gradually from 0 V, measure level (Vtht1) of pin 21 when amplitude of pin 13 output signal changes. At the same time, measure amplitude and pedestal level of pin 13 in video period after the pin 13 output signal changed in amplitude. (Vm13b, Vp13b) (5) Set bus data so that half-tone is -6 dB in on status, and perform the same measurement as the above step 4 to find gain of -6 dB half-tone and variation of pedestal level (G6th13). G6th13 = 20 log (Vm13b / Vm13) (6) Raising supply voltage to pin 21 further from Vtht1, measure level (Vttx1) of pin 21 when output signal of pin 13 (G OUT) changes in amplitude and DC level of pin 13 after the change of its output (Vtx13). (7) From results of the above steps 3 and 6, calculate low level of the output in the text mode. Vtx13 = Vtx13 - Vp13 (8) Raising supply voltage to pin 21 by 3 V from that in the above step 6, confirm that there is no change in output level of pin 13.
T31	Half-tone Gain	↑	↑	↑	↑	↑	↑	↑	↑	01H	↑	—	—	—	
T32	Text ON Ys, Low Level	↑	↑	↑	↑	↑	↑	↑	↑	↑	↑	—	—	—	
T33	Text / OSD Output, Low Level	↑	↑	↑	↑	↑	↑	↑	↑	↑	↑	—	—	—	

NOTE	ITEM	TEST CONDITION (Unless otherwise specified : H, RGB VCC = 9 V ; VDD, Fsc VDD, Y/C VCC = 5 V ; Ta = 25 ± 3°C ; BUS = preset value)										MEASURING METHOD		
		SW. MODE		SUB-ADDRESS & BUS DATA										
		S18	S19	S20	S21	S22	S31	S33	S51	15H	04H			
T34	Text RGB Output, High Level	A	A	A	A	B	B	B	A	—	02H 40H	—	—	(1) Input stepping signal whose amplitude is 0.3V in video period to pin 31 (Y IN) and pin 48 (Sync IN). (2) Set bus data so that blanking and half-tone are off. (3) Connect power supply to pin 21 (Digital Ys). While impressing 0 V to it, measure pedestal level of pin 13 output signal (G OUT) (Vpl13). (4) Connect power supply to pin 19 (Digital G IN) and impress it with 2 V. (5) Raising supply voltage to pin 21 gradually from 0 V, measure video level of pin 21 after output signal of pin 13 changed (Vlx13). (6) From measurement results of the above steps 3 and 5, calculate high level in the text mode. $V_{mt13} = V_{tx13} - V_{pt13}$ (7) Raising supply voltage to pin 21 further from that in the step 5, measure level (Vtost) of pin 21 when the level of pin 13 output signal changes from that in the step 5 to -6 dB as half-tone data is set to ON (the 6th step of Notes T30 to T34). (8) In the condition of the above step 7, raise voltage impressed to pin 19 to 3 V and measure output voltage of pin 13 (Vos13). (9) From results of the above steps 3 and 7, calculate high level of the output in the OSD mode. $V_{mos13} = V_{os13} - V_{pt13}$
T35	OSD Ys ON, Low Level	↑	↑	↑	↑	↑	↑	↑	↑	—	↑	—	—	
T36	OSD RGB Output, High Level	↑	↑	↑	↑	↑	↑	↑	↑	—	↑	—	—	

NOTE	ITEM	TEST CONDITION (Unless otherwise specified : H, RGB VCC = 9 V ; VDD, Fsc VDD, Y/C VCC = 5 V ; Ta = 25 ± 3°C ; BUS = preset value)															
		SW MODE										MEASURING METHOD					
		S18	S19	S20	S21	S22	S31	S33	S34	S51	SUB-ADDRESS & BUS DATA						
T37	Text Input Threshold Level	A	A	A	A	B	B	B	B	B	A	—	—	—	—	—	<p>(1) Connect power supply to pin 21 (Digital Ys) and impress 1.5V to it.</p> <p>(2) Connect power supply to pin 19 (Digital G IN). While raising supply voltage gradually from 0 V, measure supply voltage when output signal of pin 13 (G OUT) changes (Vtxt).</p> <p>(3) Raising the supply voltage to pin 19 furthermore to 4 V, confirm that there is no change in the output signal of pin 13 (G OUT).</p>
T38	OSD Input Threshold Level	↑	↑	↑	↑	↑	↑	↑	↑	↑	↑	—	—	—	—	—	<p>(1) Connect power supply to pin 21 (Digital Ys) and impress 2.5V to it.</p> <p>(2) Connect power supply to pin 19 (Digital G IN). While raising supply voltage gradually from 0 V, measure supply voltage when output signal of pin 13 (G OUT) changes (Vosd).</p> <p>(3) Raising the supply voltage to pin 19 furthermore to 4 V, confirm that there is no change in the output signal of pin 13 (G OUT).</p>

NOTE	ITEM	TEST CONDITION (Unless otherwise specified : H, RGB VCC = 9 V ; VDD, Fsc VDD, Y/C VCC = 5 V ; Ta = 25 ± 3°C ; BUS = preset value)																
		SW MODE							SUB-ADDRESS & BUS DATA									
		S18	S19	S20	S21	S22	S31	S33	S34	S51								
T39	OSD Mode Switching Rise-Up Time	A	A	A	A	B	B	B	B	A	B	A	—					
T40	OSD Mode Switching Rise-Up Transfer Time	↑	↑	↑	↑	↑	↑	↑	↑	↑	↑	↑	—					
T41	OSD Mode Switching Rise-Up Transfer Time, 3 Axes Difference	↑	↑	↑	↑	↑	↑	↑	↑	↑	↑	↑	—					
T42	OSD Mode Switching Breaking Time	↑	↑	↑	↑	↑	↑	↑	↑	↑	↑	↑	—					
T43	OSD Mode Switching Breaking Transfer Time	↑	↑	↑	↑	↑	↑	↑	↑	↑	↑	↑	—					
T44	OSD Mode Switching Breaking Transfer Time, 3 Axes Difference	↑	↑	↑	↑	↑	↑	↑	↑	↑	↑	↑	—					

MEASURING METHOD

- (1) Input a Signal Shown by (a) in the following figure to pin 21 (Digital Ys).
- (2) According to (b) in the figure, measure τ_{Rsd} , τ_{PRos} , τ_{Fosd} and τ_{PFos} for output signals of pin 14 (R OUT), pin 13 (G OUT) and pin 12 (B OUT) respectively.
- (3) Find maximum values of τ_{PRos} and τ_{PFos} respectively ($\Delta\tau_{PFos}$).

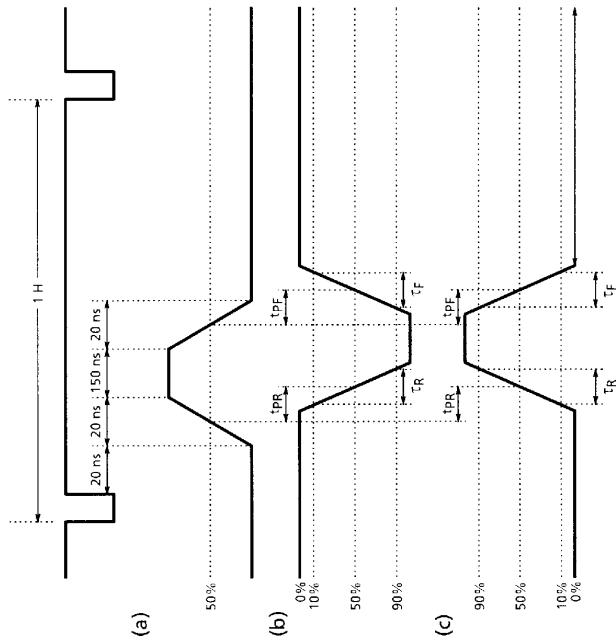

NOTE	ITEM	TEST CONDITION (Unless otherwise specified : H, RGB V _{CC} = 9 V ; V _{pp} , Fsc V _{pp} , Y/C V _{CC} = 5 V ; Ta = 25 ± 3°C ; BUS = preset value)									
		SW MODE					SUB-ADDRESS & BUS DATA				
		S18	S19	S20	S21	S22	S31	S33	S34	S51	
T45	OSD Hi DC Switching Rise-Up Time	A	A	A	A	B	B	B	B	A	—
T46	OSD Hi DC Switching Rise-Up Transfer Time	↑	↑	↑	↑	↑	↑	↑	↑	↑	—
T47	OSD Hi DC Switching Rise-Up Transfer Time, 3 Axes Difference	↑	↑	↑	↑	↑	↑	↑	↑	↑	—
T48	OSD Hi DC Switching Breaking Time	↑	↑	↑	↑	↑	↑	↑	↑	↑	—
T49	OSD Hi DC Switching Breaking Transfer Time	↑	↑	↑	↑	↑	↑	↑	↑	↑	—
T50	OSD Hi DC Switching Breaking Transfer Time, 3 Axes Difference	↑	↑	↑	↑	↑	↑	↑	↑	↑	—

MEASURING METHOD

(1) Supply pin 21 (Digital Ys) with 2.5 V.
 (2) Input 5 V_{p-p} signal shown by (a) in the figure to pin 18 (Digital R IN).
 (3) Referring to (b) of the following figure, measure τRoh, τFoh and tPFoh for output signal of pin 14 (R OUT).
 (4) Input 5 V_{p-p} signal shown by (a) in the figure to pin 19 (Digital G IN).
 (5) Perform the same measurement as the above step 3 for pin 13 output (G OUT) referring to (b) of the following figure.
 (6) Input 5 V_{p-p} signal shown by (a) in the figure to pin 20 (Digital B IN).
 (7) Perform the same measurement as the above step 3 for pin 12 output (B OUT) referring to (b) of the following figure.
 (8) Find maximum axes differences in tPRoh and tPFoh among the three outputs (tPRoh, tPFoh).

NOTE	ITEM	TEST CONDITION (Unless otherwise specified : H, RGB V _{CC} = 9V ; V _{DD} , Fsc V _{DD} , Y/C V _{CC} = 5V ; Ta = 25 ± 3°C ; BUS = preset value)																
		SW MODE		SUB-ADDRESS & BUS DATA								MEASURING METHOD						
		S21	S22	S31	S33	S34	S51			06H								
T51	RGB Contrast Control Characteristic	B	A	B	B	B	A			FFH								<p>(1) Input 0.3V synchronizing signal to pin 48 (Sync IN).</p> <p>(2) Supply 5V of external supply voltage to pin 22 (Analog Ys).</p> <p>(3) Set bus data on drive at center value.</p> <p>(4) Input TG7 sine wave signal (f = 100 kHz, video amplitude = 0.5V) to pin 23 (Analog R IN).</p> <p>(5) While changing data on RGB contrast from maximum (FF) to minimum (00), measure maximum and minimum amplitudes of pin 14 (R OUT) in video period. At the same time, measure video amplitude of pin 14 when the bus data is set at the center value (80). (Vc14mx, Vc14mn, D14c80)</p> <p>(6) In the same manner as the above steps 4 and 5, measure output signal of pin 13 with input of the same external power supply to pin 24 (Analog G IN), and measure output signal of pin 12 with input of the same power supply to pin 25 (Analog B IN). (Vc12mx, Vc12mn, D12c80).</p> <p>(7) Find amplitude ratio between signal with maximum unicolor data and signal with minimum unicolor data in conversion into decibel (ΔV13ct).</p>

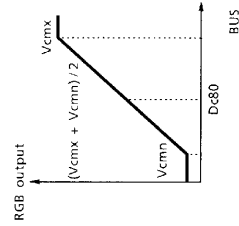

NOTE	ITEM	TEST CONDITION (Unless otherwise specified : H, RGB VCC = 9 V ; VDD, Fsc VDD, Y/C VCC = 5 V ; Ta = 25 ± 3 °C ; BUS = preset value)													
		SW MODE			SUB-ADDRESS & BUS DATA								MEASURING METHOD		
		521	522	531	533	534	551								
T52	Analog RGB AC Gain	B	A	B	B	A	—	—	—	—	—	—	—	—	In the setting condition of the Note T52, calculate output / input gain (double) with contrast data being set maximum. G = Vc13mx / 0.5 V
T53	Analog RGB Frequency Characteristic	↑	↑	↑	↑	↑	—	—	—	—	—	—	—	—	(1) Input 0.3 V synchronizing signal to pin 48 (Sync IN). (2) Supply 5 V of external supply voltage to pin 22 (Analog Ys). (3) Input TG7 sine wave signal (f = 100 kHz, video amplitude = 0.5 V) to pin 24 (Analog G IN). (4) Set bus data so that contrast is maximum and drive is set at center value. (5) Measure video amplitude of pin 13 (G OUT) and calculate output / input gain (double) (G6M). (6) From measurement results of the above step 5 and the preceding Note 53, find frequency characteristic. Gf = 20 log (G6M / G)

NOTE	ITEM	TEST CONDITION (Unless otherwise specified : H, RGB V _{CC} = 9 V ; V _{DD} , Fsc V _{DD} , Y/C V _{CC} = 5 V ; Ta = 25 ± 3°C ; BUS = preset value)										
		SW MODE			SUB-ADDRESS & BUS DATA							MEASURING METHOD
		S21	S22	S31	S33	S34	S51	01H	06H			
T54	Analog RGB Dynamic Range	B	A	B	B	A						(1) Input 0.3 V synchronizing signal to pin 48 (Sync IN). (2) Supply 5 V of external supply voltage to pin 22 (Analog Ys). (3) Set bus data so that contrast is minimum and drive is set at center value. (4) While inputting stepping signal to pin 24 (Analog G IN), increase video amplitude gradually from 0. (5) Measure video amplitude of pin 24 when video voltage of pin 13 (G OUT) does not change.
T55	RGB Brightness Control Characteristic	↑	↑	↑	↑	↑		FFH				(1) Short circuit pin 31 (Y IN), pin 33 (B-Y IN) and pin 34 (R-Y IN) in AC coupling. (2) Input 0.3 V synchronizing signal to pin 48 (Sync IN). (3) Set bus data on RGB cutoff at center value. (4) Supply 5 V of external supply voltage to pin 22 (Analog Ys). (5) While changing data brightness from maximum to minimum, measure maximum and minimum voltages of pin 13 (G OUT) in video period. (max : Vbrmx, min : Vbrmn)
T56	RGB Brightness Center Voltage	↑	↑	↑	↑	↑		80H				(6) Set bus data on brightness at center value and measure video voltage of pin 13 (G OUT) (Vbcnt). (7) On the condition that bus data with which Vbrmx is obtained in measurement of the above step 5 is Dbrmx and bus data with which Vbrmn is obtained in measurement of the above step 5 is Dbrmn, calculate sensitivity of brightness data ($\Delta Vbrt$). $\Delta Vbrt = (Vbrmx - Vbrmn) / (Dbrmx - Dbrmn)$
T57	RGB Brightness Data Sensitivity	↑	↑	↑	↑	↑						(1) Input TG7 sine wave signal (f = 100 kHz, video amplitude = 0.3 V) to pin 23 (Analog R IN). (2) Supply 5 V of external supply voltage to pin 22 (Analog Ys) and raise the voltage gradually from 0 V. (3) Measure voltage at pin 22 when signal 1 is output from pin 14 (R OUT) (Vanath).
T58	Analog RGB Mode ON Voltage	↑	↑	↑	↑	↑		80H				

NOTE	ITEM	TEST CONDITION (Unless otherwise specified : H, RGB VCC = 9 V ; VDD, Fsc VDD, Y/C VCC = 5 V ; Ta = 25 ± 3°C ; BUS = preset value)											
		SW MODE						SUB-ADDRESS & BUS DATA					MEASURING METHOD
		S21	S22	S31	S33	S34	S51	—	—	—	—	—	
T59	Analog RGB Switching Rise-Up Time	B	A	B	B	A	—	—	—	—	—	—	(1) Supply signal (2 V _{p-p}) shown by (a) in the following figure to pin 22 (Analog Ys). (2) Referring to (b) of the following figure, measure t _{Rana} , t _{pRan} , t _{Fana} and t _{pFan} for outputs of pin 14 (R OUT), pin 13 (G OUT) and pin 12 (B OUT). (3) Find maximum values of t _{pRan} and t _{pFan} respectively (Δt _{pRan} , Δt _{pFan}).
T60	Analog RGB Switching Rise-Up Transfer Time	↑	↑	↑	↑	↑	—	—	—	—	—	—	
T61	Analog RGB Switching Rise-Up Transfer Time, 3 Axes Difference	↑	↑	↑	↑	↑	—	—	—	—	—	—	
T62	Analog RGB Switching Breaking Time	↑	↑	↑	↑	↑	—	—	—	—	—	—	
T63	Analog RGB Switching Breaking Transfer Time	↑	↑	↑	↑	↑	—	—	—	—	—	—	
T64	Analog RGB Switching Breaking Transfer Time, 3 Axes Difference	↑	↑	↑	↑	↑	—	—	—	—	—	—	

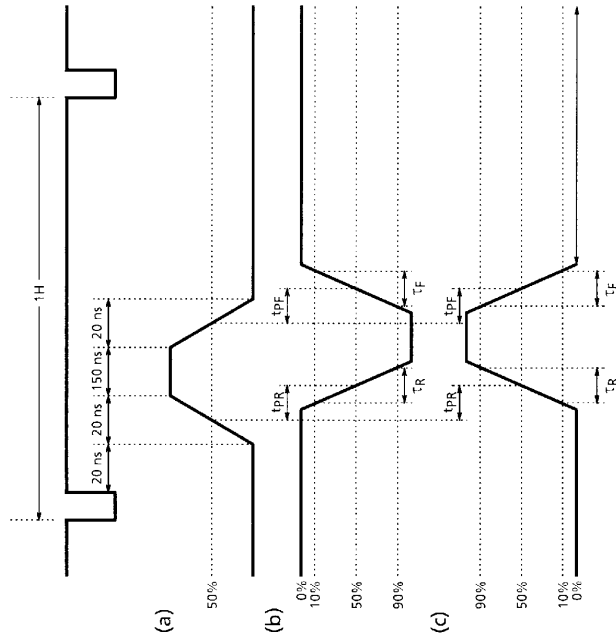

NOTE	ITEM	TEST CONDITION (Unless otherwise specified : H, RGB V _{CC} = 9 V ; V _{DD} , Fsc V _{DD} , Y/C V _{CC} = 5 V ; Ta = 25 ± 3°C ; BUS = preset value)									
		SW MODE			SUB-ADDRESS & BUS DATA						
		S21	S22	S31	S33	S34	S51				
T65	Analog RGB Hi Switching Rise-Up Time	B	A	B	B	A	—	—	—	—	—
T66	Analog RGB Hi Switching Rise-Up Transfer Time	↑	↑	↑	↑	—	—	—	—	—	—
T67	Analog RGB Hi Switching Rise-Up Transfer Time, 3 Axes Difference	↑	↑	↑	↑	—	—	—	—	—	—
T68	Analog RGB Hi Switching Breaking Time	↑	↑	↑	↑	—	—	—	—	—	—
T69	Analog RGB Hi Switching Breaking Transfer Time	↑	↑	↑	↑	—	—	—	—	—	—
T70	Analog RGB Hi Switching Breaking Transfer Time, 3 Axes Difference	↑	↑	↑	↑	—	—	—	—	—	—

MEASURING METHOD

- (1) Supply 2 V to pin 22 (Analog Ys).
- (2) Input 0.5 V_{p-p} signal shown by (a) in the following figure to pin 23 (Analog R IN).
- (3) Referring to (b) of the following figure, measure t_{RanH}, t_{PRah}, t_{FanH} and t_{PFah} for output of pin 14 (R OUT).
- (4) Input 0.5 V_{p-p} signal shown by (a) in the following figure to pin 24 (Analog G IN).
- (5) Referring to (b) of the following figure, perform the same measurement as the above step 3 for output of pin 13 (G OUT).
- (6) Input 0.5 V_{p-p} signal shown by (a) in the following figure to pin 25 (Analog B IN).
- (7) Referring to (b) of the following figure, perform the same measurement as the above step 3 for output of pin 12 (B OUT).
- (8) Find maximum axes difference in t_{PRoh} and t_{PFoh} among the three outputs (Δt_{PRah}, Δt_{PFah}).

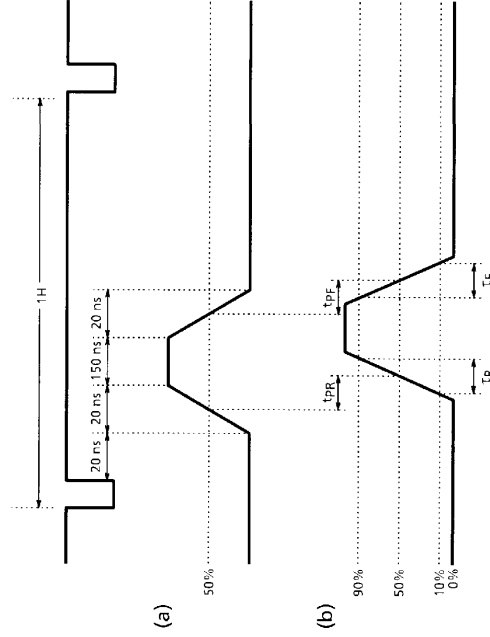

NOTE	ITEM	TEST CONDITION (Unless otherwise specified : H, RGB VCC = 9 V ; VDD, Fsc VDD, Y/C VCC = 5 V ; Ta = 25 ± 3°C ; BUS = preset value)																
		SW MODE			SUB-ADDRESS & BUS DATA							MEASURING METHOD						
		521	522	531	533	534	551											
T71	TV-Analog RGB Crosstalk	B	A	B	B	B	A	—	—	—	—	—	—	—	—	—	—	(1) Input TG7 sine wave signal (f = 4 MHz, video amplitude = 0.5V) to pin 31 (Y2 IN). (2) Short circuit pin 25 (Analog G IN) in AC coupling. (3) Input 0.3 V synchronizing signal to pin 48 (Sync IN). (4) Set bus data so that contrast is maximum, Y sub contrast and drive are set at center value. (5) Supply pin 22 (Analog Ys) with 0 V of external power supply. (6) Measure video voltage of output signal of pin 13 (G OUT) (Vtg). (7) Supply pin 22 (Analog Ys) with 2 V of external power supply. (8) Measure video voltage of output signal of pin 13 (G OUT) (Vana). (9) From measurement results of the above steps 5 and 7, calculate crosstalk from TV to analog RGB. Crta = 20 fog (Vana / Vtv)
T72	Analog RGB-TV Crosstalk	↑	↑	↑	↑	↑	↑	—	—	—	—	—	—	—	—	—	—	(1) Short circuit pin 31 (Y2 IN), pin 34 (R-Y IN) and pin 33 (B-Y IN) in AC coupling. (2) Input 0.3 V synchronizing signal to pin 48 (Sync IN). (3) Set bus data so that contrast is maximum and drive is set at center value. (4) Input TG7 sine wave signal (f = 4 MHz, video amplitude = 0.5 V) to pin 24 (Analog G IN). (5) Supply pin 22 (Analog Ys) with 0 V of external power supply. (6) Measure video voltage of output signal of pin 13 (G OUT) (Vant). (7) Supply pin 22 (Analog Ys) with 2 V of external power supply. (8) Measure video voltage of output signal of pin 13 (G OUT) (Vtan). (9) From measurement results of the above steps 6 and 8, calculate crosstalk from analog RGB to TV. Crant = 20 fog (Vant / Vtan)

NOTE	ITEM	TEST CONDITION (Unless otherwise specified : H, RGB V _{CC} = 9V ; V _{DD} , Fsc, V _{DD} , Y/C, V _{CC} = 5V ; Ta = 25 ± 3°C ; BUS = preset value)												
		SW MODE			SUB-ADDRESS & BUS DATA							MEASURING METHOD		
		S21	S22	S31	S33	S34	S51		01H	15H				
T73	ABL Point Characteristic	B	B	B	B	A	—	—	FFH	90H	—	—	—	—
										10H				
										F0H				
T74	ACL Characteristic	↑	↑	↑	↑	↑	—	—	—	—	—	—	—	—
T75	ABL Gain Characteristic	↑	↑	↑	↑	↑	—	—	FFH	10H	—	—	—	—
										00H				
										1CH				

TB1245N-94

SECAM SECTION

NOTE	ITEM	TEST CONDITION (Unless otherwise specified : H, RGB VCC = 9V ; VDD, Fsc VDD, Y/C VCC = 5V ; Ta = 25 ± 3°C)																				MEASURING METHOD		
		S	BUS : TEST MODE					BUS : NORMAL CONTROL MODE																
			02H	D3	D2	D7	D5	D4	0FH	D4	D7	D5	D4	D3	D2	D1	D0		D3	D2	D1		D0	
S1	Bell Monitor Output Amplitude	ON	0	1	0	0	0	1	0	0	0	0	0	0	0	0	0	0	0	0	0	0	1	(1) Input 200 mV _{p-p} (R-Y ID), 75% chroma color bar signal (SECAM system) to pin 42. (2) Measure amplitude of R-Y ID output of pin 36 as ebmo.
S2	Bell Filter f ₀	↑	↑	↑	↑	↑	↑	↑	↑	↑	↑	↑	↑	↑	↑	↑	↑	↑	↑	↑	↑	↑	(1) While supplying 20 mV _{p-p} CW sweep signal from network analyzer to pin 36 and monitoring output signal of pin 36 with the network analyzer, measure frequency having maximum gain as foBEL of the bell frequency characteristic. (2) Find difference between foBEL and 4.286 MHz as foB-C.	
S3	Bell Filter f ₀ Variable Range	↑	↑	↑	↑	↑	↑	↑	↑	↑	↑	↑	↑	↑	↑	↑	↑	↑	↑	↑	↑	↑	(1) The same procedure as the steps 1 and 2 of the Note S2. (2) Measure foBEL in different condition that SUB (IF) D1D0 = (00) or (11), and find difference of each measurement result from 4.286 MHz as foB-L or foB-H.	
S4	Bell Filter Q	↑	↑	↑	↑	↑	↑	↑	↑	↑	↑	↑	↑	↑	↑	↑	↑	↑	↑	↑	0	1	(1) The same procedure as the step 1 of the Note S2. (2) While monitoring output signal of pin 36 with network analyzer, measure Q of bell frequency characteristic as QBEL. QBEL = (QMAX - 3 dB band width) / foBEL	
S5	Color Difference Output Amplitude	OFF	—	—	—	—	—	0	↑	↑	↑	↑	↑	↑	↑	↑	↑	↑	↑	↑	↑	↑	(1) Input 200 mV _{p-p} (R-Y ID), 75% chroma color bar signal (SECAM system) to pin 42. (2) Measure color difference levels VRS and VBS with signals of pin 35 and pin 36.	
S6	Color Difference Relative Amplitude	↑	—	—	—	—	—	↑	↑	↑	↑	↑	↑	↑	↑	↑	↑	↑	↑	↑	↑	↑	(3) Calculate relative amplitude from VRS / VBS.	

NOTE	ITEM	TEST CONDITION (Unless otherwise specified : H, RGB VCC = 9V ; VDD, Fsc VDD, Y/C VCC = 5V ; Ta = 25 ± 3°C)																						
		BUS : TEST MODE								BUS : NORMAL CONTROL MODE								MEASURING METHOD						
		S	02H	D3	D2	D7	D5	D4	D4	0FH	10H	D3	D2	D1	D0	D7	D6		D5	D4	D3	D2	D1	D0
S7	Color Difference Attenuation Quantity	OFF	—	—	—	—	—	—	0	0	0	0	0	0	0	1	0	0	0	0	0	0	1	(1) The same procedure as the steps 1 and 2 of the Note S5. (2) In the condition that SUB (IF) D6 = 1, measure amplitudes of color difference signals of pin 35 and pin 36 as VRSA and VBSA respectively, and find SATTR and SATTB from measurement results. SATTR = 20 log (VRSA / VRS), SATTB = 20 log (VBSA / VBS)
S8	Color Difference S/N Ratio	↑	—	—	—	—	—	↑	↑	↑	↑	↑	↑	↑	0	↑	↑	↑	↑	↑	↑	↑	(1) The same procedure as the steps 1 and 2 of the Note S5. (2) Input non-modulated 200 Vp-p (R-Y) chroma signal to pin 42. (3) Measure noise amplitude nR and nB (mVp-p) appearing in color difference signals of pin 35 and pin 36 respectively. (4) Find S/N ratio by the following equation. SNB-S = 20 log (2√2 × VBS / nB × 10E - 3) SNR-S = 20 log (2√2 × VRS / nR × 10E - 3)	
S9	Linearity	↑	—	—	—	—	—	↑	↑	↑	↑	↑	↑	↑	↑	↑	↑	↑	↑	↑	↑	↑	(1) The same procedure as the step 1 of the Note S5. (2) Measure and calculate amplitude of black bar levels in output waveforms of pin 35 and pin 36 as shown below. LinB = V [cyan] / V [red] / (Maximum positive / negative amplitudes in respective axes) LinR = V [yellow] / V [blue]	

APPLICATION CIRCUIT

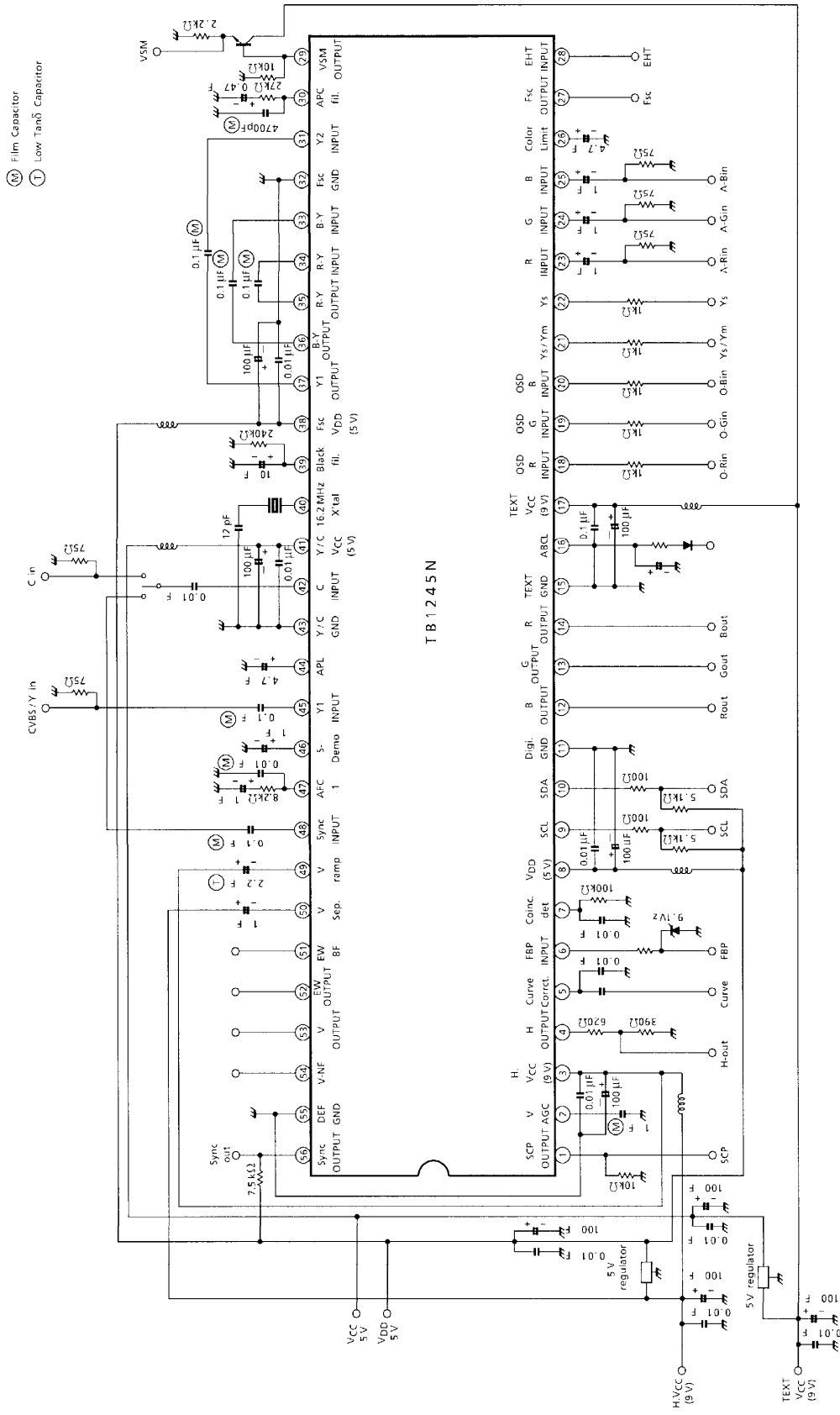

T B 1 2 4 5 N

PACKAGE DIMENSIONS
SDIP56-P-600-1.78

Unit : mm

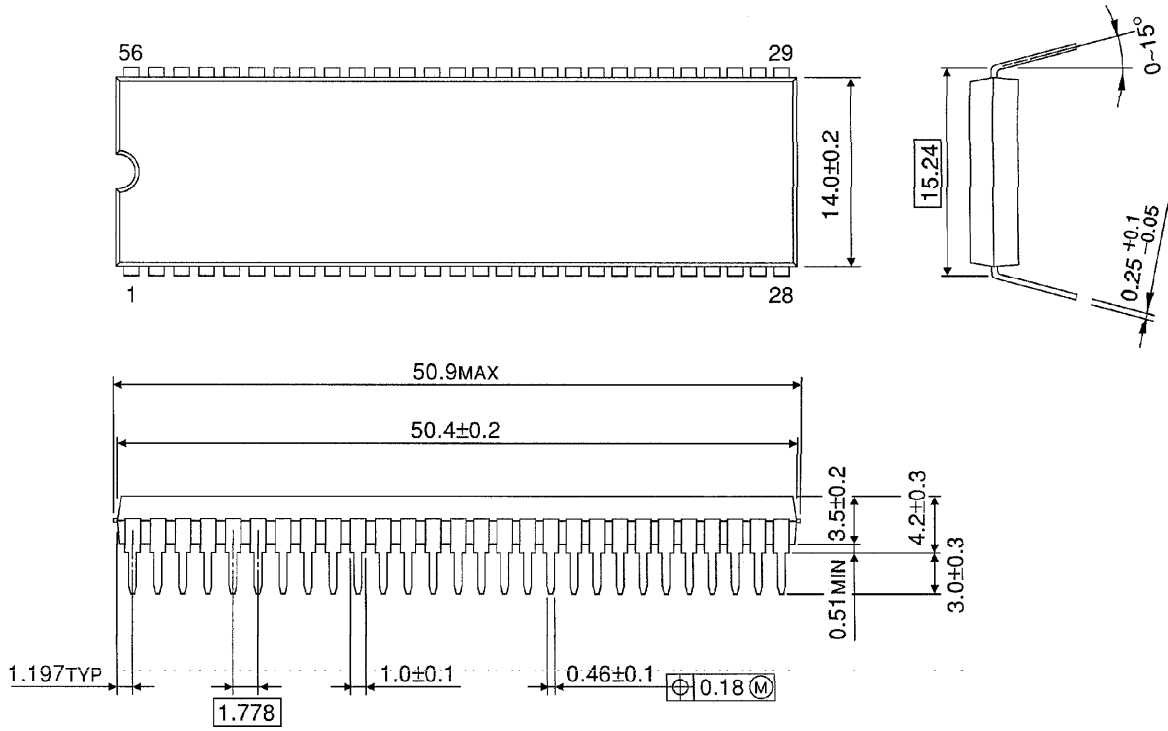

Weight : 5.55 g (Typ.)